



greenteQ

# greenteQ Door hardware Q04

EDITION 2013



Simply everything.

Everything simple.



# Always at your side - the VBH Enhanced Service Package

**More products. More brands. More choice.**

**Simply everything** you need to manufacture and install windows and doors is available from VBH.

By 'everything' we mean that our products deliver everything you would expect in terms of quality. This means you have access to the most comprehensive, and consistently high quality range in the sector.

**Everything simple**, from the very first conversation through to everyday contact, from good, old fashioned face-to-face meetings to the use of modern communications. At VBH, the people are there to help you, going about our work in a helpful and friendly way. Our modern communication tools are designed for maximum efficiency and reliability, so that you can concentrate on the essentials: Your customers.

The expert brand for window and door hardware is always there for you. We are with you on the road to success. Benefit from our efficient working practices and profit from our staff's expert knowledge. Put simply, you can expect a good deal more from us than from ordinary suppliers. Rely on the VBH Enhanced Service Package - at any time.



## LEVER HANDLE SETS, PULL HANDLES AND LEVER HANDLE SETS FOR FRAMED DOORS



Lever handle sets Stainless steel	4 - 11	Pull handles Stainless steel	22 - 28
Lever handles Stainless steel	12	Pull handle systems Stainless steel	29 - 30
Security rosettes Stainless steel	13 - 14	Lever handle sets framed doors Stainless steel	31 - 33
Security rosettes Aluminium	15	Drilling jig set	34
Lever handles framed doors Aluminium	16	Lever handle sets framed doors Aluminium	35 - 40
Sliding rosettes framed doors Aluminium	17	Drilling jig set	41
Lever handles Stainless steel	18 - 19		
Sliding rosettes Stainless steel	20 - 21		

## MORTISE LOCKS, MULTI-POINT LOCKS AND PROFILE CYLINDERS



Mortise locks	42 - 44	Profile cylinder keyed different	50 - 52
Accessories: Middle locking plate	45	Profile cylinder keyed alike No. 1	53 - 55
Multi-points locks	46 - 48	Profile cylinder keyed alike No. 2	56 - 58
Accessories: Additional striking plate	47	Profile cylinder keyed alike No. 3	59 - 61
Accessories: Middle locking plate	49	Profile cylinder keyed alike No. 4	62 - 63
		Profile cylinder keyed alike No. 5	64 - 65
		Profile cylinder WC	66
		Escutcheon	66 - 67

## FRONT DOOR SEALS, DOOR HINGES AND SUPPLEMENTARY RANGE



Front door seal	68	Door knockers	75 - 76
Door hinge TB 100.ZD.K	69	Door viewer	76
Accessories: Set of plastic accessories, packer, fastening set, drilling jig	70	Signs	77 - 78
Door hinge TB 120.ZD.K	71	Floor doorstop	78
Accessories: Set of plastic accessories, packer, fastening set, drilling jig, telescopic bar	72	Wall mounted doorstop	78
	73	House numbers	79
	74	Weldable corner connector	79 - 81
		Threshold systems	82

## INFORMATION



Subject to change reserved.  
Technical data, drawings and dimensions are not binding.

Colour aberration from original product may be caused by printing and shall not give rise to a claim.

# DOOR HARDWARE

## Lever handle sets greenteQ Stainless steel

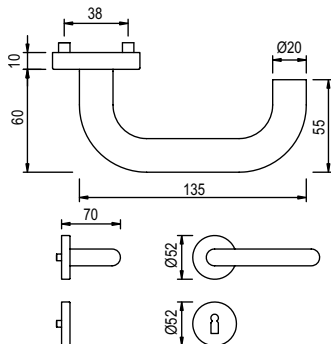

### greenteQ Lever handle set for internal doors DG 60L.ER.RS

greenteQ lever handle set for internal doors DG 60L.ER.RS; certificated acc. to EN 1906:2010; with 8 mm square spindle; loose lever on plastic base, with spring mechanism; invisible, through-fixing; with screws for door thickness 37- 42 mm; stainless steel polished / matt brushed.



#### Technical data:

- Bearing: loose lever with spring mechanism
- Diameter of rosette: 52 mm
- Height of edge: 10 mm
- For door thickness: 37 - 42 mm
- Screws: inclusive 4 x M5 x 50/55 mm

Material	Surface	Type of punch	Square spindle	PU	VBH Article-No.
Stainless steel	matt brushed	BB	8 mm	1 set	396.943 / 6510 
Stainless steel	matt brushed	PZ	8 mm	1 set	396.944 / 6510 
Stainless steel	matt brushed	WC	8 mm	1 set	396.945 / 6510 

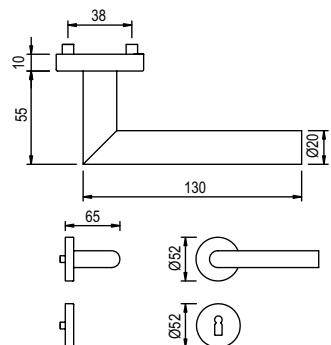

### greenteQ Lever handle set for internal doors DG 61L.ER.RS

greenteQ lever handle set for internal doors DG 61L.ER.RS; certificated acc. to EN 1906:2010; with 8 mm square spindle; loose lever on plastic base, with spring mechanism; invisible, through-fixing; with screws for door thickness 37- 42 mm; stainless steel polished / matt brushed.



#### Technical data:

- Bearing: loose lever with spring mechanism
- Diameter of rosette: 52 mm
- Height of edge: 10 mm
- For door thickness: 37 - 42 mm
- Screws: inclusive 4 x M5 x 50/55 mm

Material	Surface	Type of punch	Square spindle	PU	VBH Article-No.
Stainless steel	matt brushed	BB	8 mm	1 set	396.946 / 6510 
Stainless steel	matt brushed	PZ	8 mm	1 set	396.947 / 6510 
Stainless steel	matt brushed	WC	8 mm	1 set	396.948 / 6510 

# DOOR HARDWARE

## Lever handle sets greenteQ Stainless steel

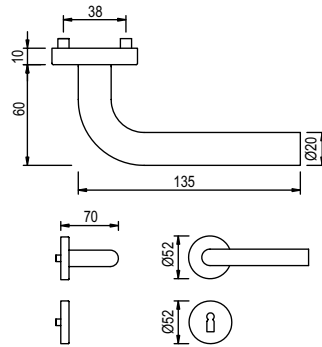

### greenteQ Lever handle set for internal doors DG 62L.ER.RS

greenteQ lever handle set for internal doors DG 62L.ER.RS; certificated acc. to EN 1906:2010; with 8 mm square spindle; loose lever on plastic base, with spring mechanism; invisible, through-fixing; with screws for door thickness 37- 42 mm; stainless steel polished / matt brushed.



**Technical data:**

- Bearing: loose lever with spring mechanism
- Diameter of rosette: 52 mm
- Height of edge: 10 mm
- For door thickness: 37 - 42 mm
- Screws: inclusive 4 x M5 x 50/55 mm

Material	Surface	Type of punch	Square spindle	PU	VBH Article-No.
Stainless steel	matt brushed	BB	8 mm	1 set	396.949 / 6510 
Stainless steel	matt brushed	PZ	8 mm	1 set	396.950 / 6510 
Stainless steel	matt brushed	WC	8 mm	1 set	396.951 / 6510 

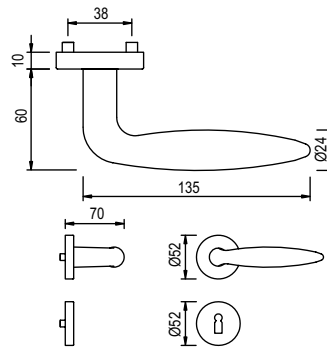

### greenteQ Lever handle set for internal doors DG 69L.ER.RS

greenteQ lever handle set for internal doors DG 69L.ER.RS; certificated acc. to EN 1906:2010; with 8 mm square spindle; loose lever on plastic base, with spring mechanism; invisible, through-fixing; with screws for door thickness 37- 42 mm; stainless steel polished / matt brushed.



**Technical data:**

- Bearing: loose lever with spring mechanism
- Diameter of rosette: 52 mm
- Height of edge: 10 mm
- For door thickness: 37 - 42 mm
- Screws: inclusive 4 x M5 x 50/55 mm

Material	Surface	Type of punch	Square spindle	PU	VBH Article-No.
Stainless steel	matt brushed	BB	8 mm	1 set	396.952 / 6510 
Stainless steel	matt brushed	PZ	8 mm	1 set	396.953 / 6510 
Stainless steel	matt brushed	WC	8 mm	1 set	396.954 / 6510 

# DOOR HARDWARE

## Lever handle sets greenteQ Stainless steel

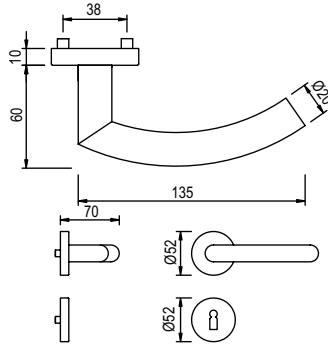

### greenteQ Lever handle set for internal doors DG 70L.ER.RS

greenteQ lever handle set for internal doors DG 70L.ER.RS; certificated acc. to EN 1906:2010; with 8 mm square spindle; loose lever on plastic base, with spring mechanism; invisible, through-fixing; with screws for door thickness 37- 42 mm; stainless steel polished / matt brushed.



**Technical data:**

- Bearing: loose lever with spring mechanism
- Diameter of rosette: 52 mm
- Height of edge: 10 mm
- For door thickness: 37 - 42 mm
- Screws: inclusive 4 x M5 x 50/55 mm

Material	Surface	Type of punch	Square spindle	PU	VBH Article-No.
Stainless steel	matt brushed	BB	8 mm	1 set	396.955 / 6510 
Stainless steel	matt brushed	PZ	8 mm	1 set	396.956 / 6510 
Stainless steel	matt brushed	WC	8 mm	1 set	396.957 / 6510 

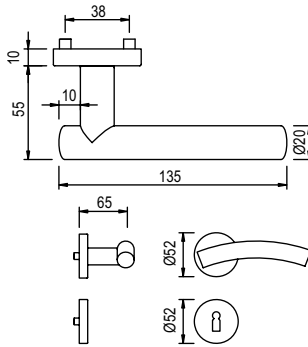

### greenteQ Lever handle set for internal doors DG 71L.ER.RS

greenteQ lever handle set for internal doors DG 71L.ER.RS; certificated acc. to EN 1906:2010; with 8 mm square spindle; loose lever on plastic base, with spring mechanism; invisible, through-fixing; with screws for door thickness 37- 42 mm; stainless steel polished / matt brushed.



**Technical data:**

- Bearing: loose lever with spring mechanism
- Diameter of rosette: 52 mm
- Height of edge: 10 mm
- For door thickness: 37 - 42 mm
- Screws: inclusive 4 x M5 x 50/55 mm

Material	Surface	Type of punch	Square spindle	PU	VBH Article-No.
Stainless steel	matt brushed	BB	8 mm	1 set	396.958 / 6510 
Stainless steel	matt brushed	PZ	8 mm	1 set	396.959 / 6510 
Stainless steel	matt brushed	WC	8 mm	1 set	396.960 / 6510 

# DOOR HARDWARE

## Lever handle sets greenteQ Stainless steel

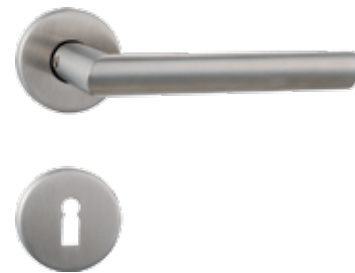
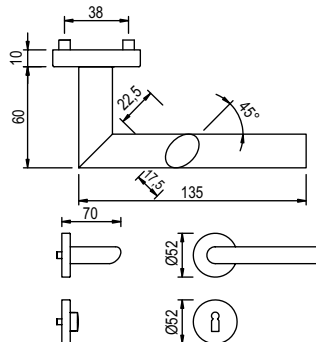

### greenteQ Lever handle set for internal doors DG 73L.ER.RS

greenteQ lever handle set for internal doors DG 73L.ER.RS; certificated acc. to EN 1906:2010; with 8 mm square spindle; loose lever on plastic base, with spring mechanism; invisible, through-fixing; with screws for door thickness 37- 42 mm; stainless steel polished / matt brushed.



#### Technical data:

- Bearing: loose lever with spring mechanism
- Diameter of rosette: 52 mm
- Height of edge: 10 mm
- For door thickness: 37 - 42 mm
- Screws: inclusive 4 x M5 x 50/55 mm

Material	Surface	Type of punch	Square spindle	PU	VBH Article-No.
Stainless steel	matt brushed	BB	8 mm	1 set	396.961 / 6510 
Stainless steel	matt brushed	PZ	8 mm	1 set	396.962 / 6510 
Stainless steel	matt brushed	WC	8 mm	1 set	396.963 / 6510 

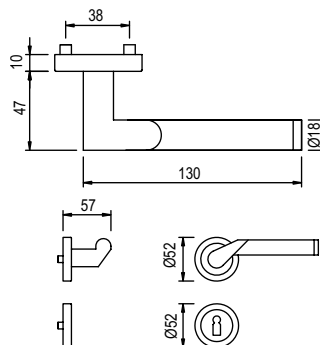

### greenteQ Lever handle set for internal doors DG 74L.ER.RS

greenteQ lever handle set for internal doors DG 74L.ER.RS; certificated acc. to EN 1906:2010; with 8 mm square spindle; loose lever on plastic base, with spring mechanism; invisible, through-fixing; with screws for door thickness 37- 42 mm; stainless steel polished / matt brushed.



#### Technical data:

- Bearing: loose lever with spring mechanism
- Diameter of rosette: 52 mm
- Height of edge: 10 mm
- For door thickness: 37 - 42 mm
- Screws: inclusive 4 x M5 x 50/55 mm

Material	Surface	Type of punch	Square spindle	PU	VBH Article-No.
Stainless steel	matt brushed	BB	8 mm	1 set	396.964 / 4265 
Stainless steel	matt brushed	PZ	8 mm	1 set	396.965 / 4265 
Stainless steel	matt brushed	WC	8 mm	1 set	396.966 / 4265 

# DOOR HARDWARE

## Lever handle sets greenteQ Stainless steel

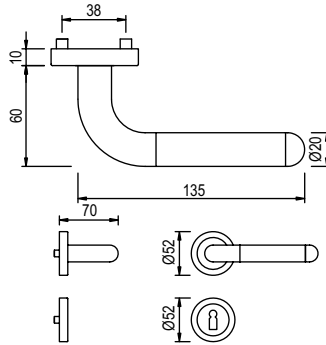

### greenteQ Lever handle set for internal doors DG 75L.ER.RS

greenteQ lever handle set for internal doors DG 75L.ER.RS; certificated acc. to EN 1906:2010; with 8 mm square spindle; loose lever on plastic base, with spring mechanism; invisible, through-fixing; with screws for door thickness 37- 42 mm; stainless steel polished / matt brushed.



#### Technical data:

- Bearing: loose lever with spring mechanism
- Diameter of rosette: 52 mm
- Height of edge: 10 mm
- For door thickness: 37 - 42 mm
- Screws: inclusive 4 x M5 x 50/55 mm

Material	Surface	Type of punch	Square spindle	PU	VBH Article-No.
Stainless steel	matt brushed	BB	8 mm	1 set	396.967 / 4265 
Stainless steel	matt brushed	PZ	8 mm	1 set	396.968 / 4265 
Stainless steel	matt brushed	WC	8 mm	1 set	396.969 / 4265 

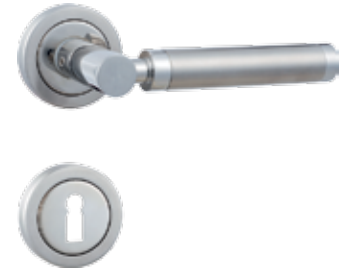
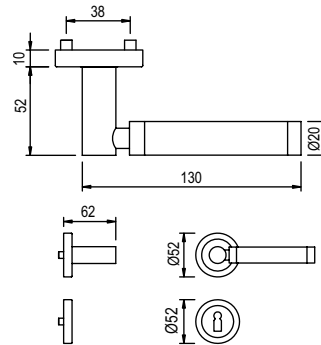

### greenteQ Lever handle set for internal doors DG 76L.ER.RS

greenteQ lever handle set for internal doors DG 76L.ER.RS; certificated acc. to EN 1906:2010; with 8 mm square spindle; loose lever on plastic base, with spring mechanism; invisible, through-fixing; with screws for door thickness 37- 42 mm; stainless steel polished / matt brushed.



#### Technical data:

- Bearing: loose lever with spring mechanism
- Diameter of rosette: 52 mm
- Height of edge: 10 mm
- For door thickness: 37 - 42 mm
- Screws: inclusive 4 x M5 x 50/55 mm

Material	Surface	Type of punch	Square spindle	PU	VBH Article-No.
Stainless steel	matt brushed	BB	8 mm	1 set	396.970 / 4265 
Stainless steel	matt brushed	PZ	8 mm	1 set	396.971 / 4265 
Stainless steel	matt brushed	WC	8 mm	1 set	396.972 / 4265 



# DOOR HARDWARE

## Lever handle sets greenteQ Stainless steel

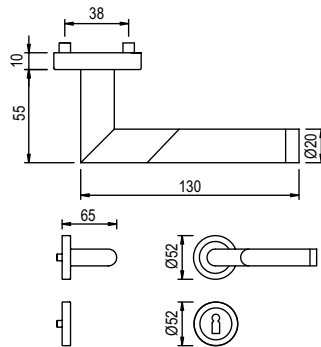

### greenteQ Lever handle set for internal doors DG 77L.ER.RS

greenteQ lever handle set for internal doors DG 77L.ER.RS; certificated acc. to EN 1906:2010; with 8 mm square spindle; loose lever on plastic base, with spring mechanism; invisible, through-fixing; with screws for door thickness 37- 42 mm; stainless steel polished / matt brushed.



**Technical data:**

- Bearing: loose lever with spring mechanism
- Diameter of rosette: 52 mm
- Height of edge: 10 mm
- For door thickness: 37 - 42 mm
- Screws: inclusive 4 x M5 x 50/55 mm

Material	Surface	Type of punch	Square spindle	PU	VBH Article-No.
Stainless steel	matt brushed	BB	8 mm	1 set	396.973 / 4265 
Stainless steel	matt brushed	PZ	8 mm	1 set	396.974 / 4265 
Stainless steel	matt brushed	WC	8 mm	1 set	396.975 / 4265 

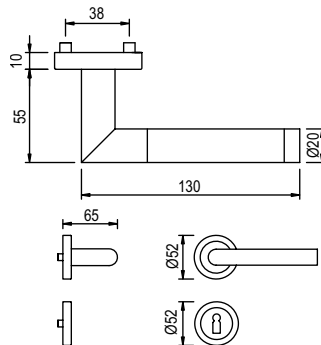

### greenteQ Lever handle set for internal doors DG 78L.ER.RS

greenteQ lever handle set for internal doors DG 78L.ER.RS; certificated acc. to EN 1906:2010; with 8 mm square spindle; loose lever on plastic base, with spring mechanism; invisible, through-fixing; with screws for door thickness 37- 42 mm; stainless steel polished / matt brushed.



**Technical data:**

- Bearing: loose lever with spring mechanism
- Diameter of rosette: 52 mm
- Height of edge: 10 mm
- For door thickness: 37 - 42 mm
- Screws: inclusive 4 x M5 x 50/55 mm

Material	Surface	Type of punch	Square spindle	PU	VBH Article-No.
Stainless steel	matt brushed	BB	8 mm	1 set	396.976 / 4265 
Stainless steel	matt brushed	PZ	8 mm	1 set	396.977 / 4265 
Stainless steel	matt brushed	WC	8 mm	1 set	396.978 / 4265 

# DOOR HARDWARE

## Lever handle sets greenteQ Stainless steel

### greenteQ Drilling jig set

The greenteQ drilling jig set for lever handle sets is prepared for the fixing of lever handle sets with round roses and lever handle sets for framed doors with long plate. The drilling jig set includes four different paper templates for rose furniture with distances of BB / PZ 72 mm, WC 78 mm or PZ 92 mm as well as for lever handle sets for framed doors with 92 mm distance. The drilling jig is made of plastic, equipped with hardened bushes and will be delivered in one practical plastic box. The required guide pins and drills are included.

#### Content:

- 1. Drilling jig
- 2. Paper templates
  - for lever handle sets for framed doors PZ 92 with long plate
  - for lever handle sets on round rose WC 78 mm distance
  - for lever handle sets on round rose BB / PZ 72 mm distance
  - for security roses PZ 92 mm distance
- 3. Knurled screw M5
- 4. Guide pins
  - Ø 8 mm (for 8 mm square spindle aperture)
  - Ø 9 mm (for 9 mm square spindle aperture)
  - Ø 10 mm (for 10 mm square spindle aperture)
  - Ø 7 mm (for BB-Lock)
  - Ø 8 mm (for WC-Lock)
  - Ø 17 mm (for PZ-Lock)
- 5. Drills
  - Ø 9 mm
  - Ø 10.5 mm



Material	PU	VBH Article-No.
Plastic with hardened bushes	1 set	396.668 / 0000

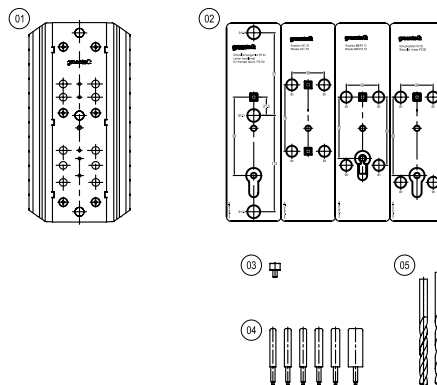

### greenteQ Lever handle set for internal doors DG 60.ER.RS

greenteQ lever handle sets for interior doors in living areas.

greenteQ lever handle set for internal doors DG 60.ER.RS; with 8 mm square spindle; lever fixed movable on metal base, with spring mechanism; invisible, through-fixing; with screws for door thickness 38- 43 mm; stainless steel matt brushed.

#### Technical data:

- Bearing: lever fixed movable with spring mechanism
- Diameter of rosette: 52 mm
- Height of edge: 8 mm
- For door thickness: 38 - 43 mm
- Screws: inclusive 4 x M5 x 50 mm and 4 x M5 x 55 mm

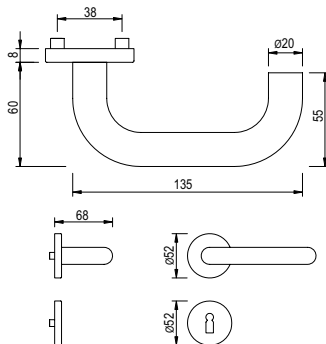

Material	Surface	Type of punch	Square spindle	PU	VBH Article-No.
Stainless steel	matt brushed	BB	8 mm	1 set	971.814 / 6500
Stainless steel	matt brushed	PZ	8 mm	1 set	971.815 / 6500
Stainless steel	matt brushed	WC	8 mm	1 set	971.816 / 6500

# DOOR HARDWARE

## Lever handle sets greenteQ Stainless steel

### greenteQ Lever handle set for internal doors DG 61.ER.RS



greenteQ lever handle sets for interior doors in living areas.

greenteQ lever handle set for internal doors DG 61.ER.RS; with 8 mm square spindle (WC set 7 mm); lever fixed movable on metal base, with spring mechanism; in 2 parts divided rose-cover to simplify assembling; invisible, through-fixing; with screws for door thickness 38- 43 mm; stainless steel matt brushed.

#### Technical data:

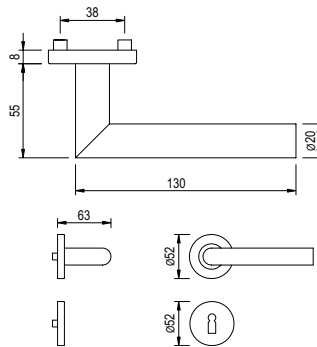
- Bearing: lever fixed movable with spring mechanism
- Diameter of rosette: 52
- Height of edge: 8 mm
- For door thickness: 38 - 43 mm
- Screws: inclusive 4xM5x50 mm and 4xM5x55 mm



Material	Surface	Type of punch	Square spindle	PU	VBH Article-No.
Stainless steel	matt brushed	BB	8 mm	1 set	971.808 / 6500 
Stainless steel	matt brushed	PZ	8 mm	1 set	971.809 / 6500 
Stainless steel	matt brushed	WC	8 mm	1 set	971.810 / 6500 

### greenteQ Lever handle set for internal doors DG 62.ER.RS



greenteQ lever handle sets for interior doors in living areas.

greenteQ lever handle set for internal doors DG 62.ER.RS; with 8 mm square spindle (WC set 7 mm); lever fixed movable on metal base, with spring mechanism; invisible, through-fixing; with screws for door thickness 38- 43 mm; stainless steel matt brushed.

#### Technical data:

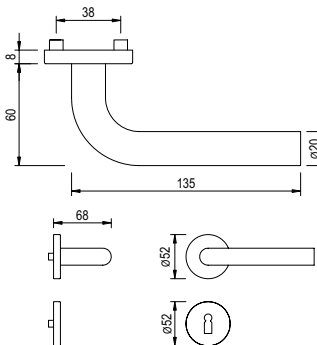
- Bearing: lever fixed movable with spring mechanism
- Diameter of rosette: 52 mm
- Height of edge: 8 mm
- For door thickness: 38 - 43 mm
- Screws: inclusive 4xM5x50 mm and 4xM5x55 mm



Material	Surface	Type of punch	Square spindle	PU	VBH Article-No.
Stainless steel	matt brushed	BB	8 mm	1 set	971.811 / 6500 
Stainless steel	matt brushed	PZ	8 mm	1 set	971.812 / 6500 
Stainless steel	matt brushed	WC	8 mm	1 set	971.813 / 6500 

# DOOR HARDWARE

## Lever handles greenteQ Stainless steel

### greenteQ Lever handle DG 60.ER.RS.LT

greenteQ lever handle DG 60.ER.RS.LT; for 8 mm square spindle; lever fixed movable on metal base; invisible fixing; stainless steel matt brushed.

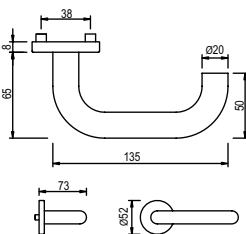



Material	Surface	Square spindle	Variants	PU	VBH Article-No.
Stainless steel	matt brushed	for 8 mm	with cams	1 pc.	994.717 / 6500 

### greenteQ Lever handle DG 61.ER.RS.LT

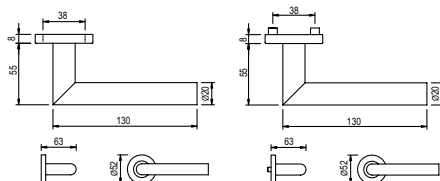
greenteQ Lever handle DG 61.ER.RS.LT; for 8 mm square spindle; lever fixed movable on metal base; in 2 parts divided rose-cover to simplify assembling; invisible fixing; stainless steel matt brushed.



Material	Surface	Square spindle	Variants	PU	VBH Article-No.
Stainless steel	matt brushed	for 8 mm	with cams	1 pc.	994.720 / 6500 
Stainless steel	matt brushed	for 8 mm	without cams	1 pc.	385.438 / 6500 

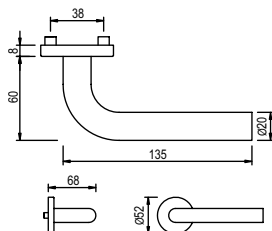

### greenteQ Lever handle DG 62.ER.RS.LT

greenteQ Lever handle DG 61.ER.RS.LT; for 8 mm square spindle; lever fixed movable on metal base; in 2 parts divided rose-cover to simplify assembling; invisible fixing; stainless steel matt brushed.



Material	Surface	Square spindle	Variants	PU	VBH Article-No.
Stainless steel	matt brushed	for 8 mm	with cams	1 pc.	994.719 / 6500 

### greenteQ Square spindle

Material	Surface	Dimension	VBH Article-No.
Steel	galvanized	8 x 60 mm	898.295 / 0060 
Steel	galvanized	8 x 70 mm	898.295 / 0070 
Steel	galvanized	8 x 80 mm	898.295 / 0080 



# DOOR HARDWARE

## Lever handles greenteQ Stainless steel

### greenteQ Half square spindle 8/10

Material	Surface	Dimension	VBH Article-No.
Steel	galvanized	8/10 x 70 mm	375.275 / 4010 



# DOOR HARDWARE

## Security rosette pair greenteQ Stainless steel

### greenteQ Outside security rosette PZ 12mm ER stainless steel

greenteQ rosettes for entrance doors, to combine with pull handles and lever handles. greenteQ outside security rosette PZ 12mm ER stainless steel; round; for profile cylinder; diameter of rosette 55 mm, height of edge 12 mm; invisible fixing; for door thickness 57 - 72 mm; stainless steel matt brushed.

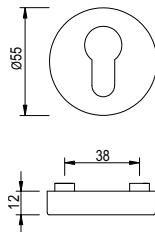

#### Technical data:

- Keyhole: PZ
- Door thickness: 57 - 72 mm
- Screws: M5 x 70 mm (2 pcs.), M5 x 80 mm (2 pcs.)
- Packaging unit: 10 pieces

Material	Surface	Height of edge	PU	VBH Article-No.
Stainless steel	matt brushed	12 mm	10 pieces	318.983 / 6500 

### greenteQ Security rosette pair PZ 12mm ER stainless steel

greenteQ rosettes for entrance doors, to combine with pull handles and lever handles. greenteQ security rosette pair PZ 12 ER round; for profile cylinder; outside: diameter of rosette 55 mm, height of edge 12 mm; inside: diameter of rosette 52 mm, height of edge 8 mm; invisible fixing; for door thickness 57 - 72 mm; stainless steel matt brushed.

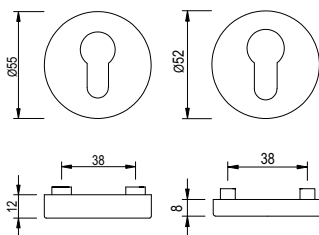

#### Technical data:

- Keyhole: PZ
- Door thickness: 57 - 72 mm
- Screws: M5 x 70 mm (2 pcs.), M5 x 80 mm (2 pcs.)
- Packaging unit: 10 pairs

Material	Surface	Height of edge	PU	VBH Article-No.
Stainless steel	matt brushed	12/8 mm	10 pairs	315.170 / 6500 

### greenteQ Security rosette pair ZA PZ 14 mm ER

greenteQ rosettes for entrance doors, to combine with pull handles and lever handles. greenteQ security rosette pair ZA PZ 14 mm ER, with cylinder cover; round; for profile cylinder; outside: diameter of rosette 55 mm, height of edge 14 mm; inside: diameter of rosette 52 mm, height of edge 8 mm; invisible fixing; door thickness 67 - 72 mm; stainless steel matt brushed.

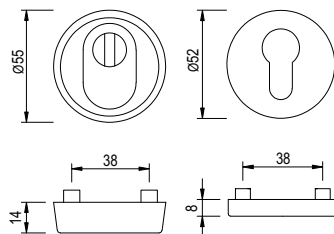

#### Technical data:

- Keyhole: PZ
- Door thickness: 67 - 72 mm
- Screws: M5 x 80 mm (2 pcs.)
- Packaging unit: 10 pieces

Material	Surface	Height of edge	PU	VBH Article-No.
Stainless steel	matt brushed	14/8 mm	10 pairs	381.878 / 6500 

# DOOR HARDWARE

## Security rosette pair greenteQ Aluminium

### greenteQ Security rosette pair ZA PZ 15 mm AL

greenteQ rosettes for entrance doors, to combine with pull handles and lever handles.  
 greenteQ security rosette pair ZA PZ 15 mm AL, with cylinder cover; round; for profile cylinder; diameter of rosette 55 mm; outside: height of edge 15 mm, for cylinder protrusion 10 - 16 mm; inside: height of edge 8 mm; invisible fixing; door thickness 67 - 72 mm; aluminium silver anodized.

**Technical data:**

- Keyhole: PZ
- Door thickness: 67 - 72 mm
- Screws: M5 x 80 mm (2 pcs.)
- Packaging unit: 10 pairs

Surface	Colour code	Height of edge	PU	VBH Article-No.
silver anodized	F1	15/8 mm	10 pairs	381.878 / 0100 

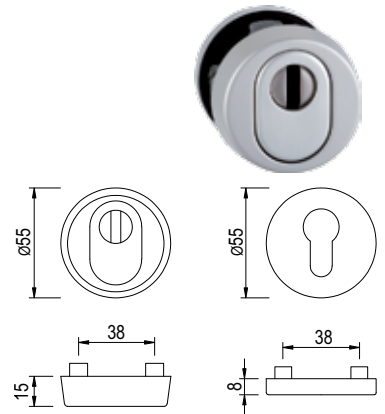

### greenteQ Security rosette pair PZ 12 mm AL

greenteQ rosettes for entrance doors, to combine with pull handles and lever handles.  
 greenteQ security rosette pair PZ 12 mm AL round; for profile cylinder; diameter of rosette 55 mm; outside: height of edge 12 mm; inside: height of edge 8 mm; invisible fixing; door thickness 57 - 72 mm; aluminium silver anodized.

**Technical data:**

- Keyhole: PZ
- Door thickness: 57-72 mm
- Screws: M5 x 70 mm (2 pcs.), M5 x 80 mm (2 pcs.)
- Packaging unit: 10 pair

Surface	Colour code	Height of edge	PU	VBH Article-No.
silver anodized	F1	12/8 mm	10 pairs	318.975 / 0100 

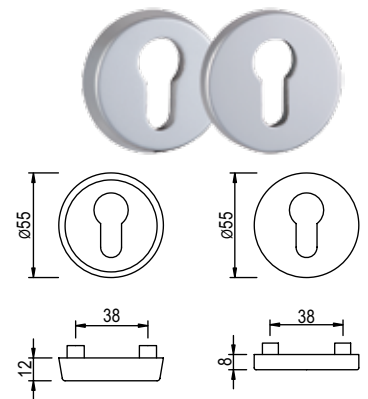





# DOOR HARDWARE

## Lever handle greenteQ Aluminium

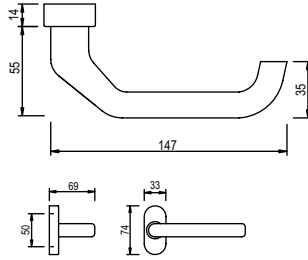

### greenteQ Lever handle DG 59.AL.ORS.LT

greenteQ lever handle DG 59.AL.ORS.LT; for 8 mm square spindle; lever fixed movable on metal base, with spring mechanism; invisible fixing; aluminium.



Surface	Colour code	Variants	Square spindle	PU	VBH Article-No.
silver anodized	F1	without cams	for 8 mm	1 pc.	316.631 / 0100 
white	RAL 9016	without cams	for 8 mm	1 pc.	316.631 / 1600 
brown	RAL 8019	without cams	for 8 mm	1 pc.	316.631 / 8019 

### greenteQ Square spindle

Material	Surface	Dimension	VBH Article-No.
Steel	galvanized	8 x 60 mm	898.295 / 0060 
Steel	galvanized	8 x 70 mm	898.295 / 0070 
Steel	galvanized	8 x 80 mm	898.295 / 0080 



### greenteQ Half square spindle 8/10

Material	Surface	Dimension	VBH Article-No.
Steel	galvanized	8/10 x 70 mm	375.275 / 4010 





# DOOR HARDWARE

## Sliding rosette greenteQ Aluminium

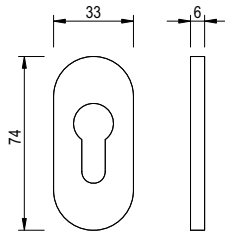

### greenteQ Sliding rosette oval 6 mm AL

greenteQ rosettes for entrance doors, to combine with pull handles and lever handles.  
greenteQ sliding rosette oval 6mm AL;  
for profile cylinder; height of edge 6 mm;  
aluminium.



#### Technical data:

- Keyhole: PZ
- Door thickness: -
- Screws: exclusive
- Packaging unit: 10 pieces

Surface	Colour code	Height of edge	PU	VBH Article-No.
silver anodized	F1	6 mm	10 pieces	359.542 / 0100 
white	RAL 9016	6 mm	10 pieces	359.542 / 1600 
brown	RAL 8019	6 mm	10 pieces	359.542 / 8019 

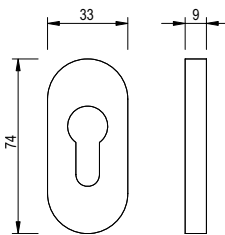

### greenteQ Sliding rosette oval 9 mm AL

greenteQ rosettes for entrance doors, to combine with pull handles and lever handles.  
greenteQ sliding rosette oval 9 mm AL;  
for profile cylinder; height of edge 9 mm;  
aluminium.



#### Technical data:

- Keyhole: PZ
- Door thickness: -
- Screws: exclusive
- Packaging unit: 10 pieces

Surface	Colour code	Height of edge	PU	VBH Article-No.
silver anodized	F1	9 mm	10 pieces	316.635 / 0100 
white	RAL 9016	9 mm	10 pieces	316.635 / 1600 
brown	RAL 8019	9 mm	10 pieces	316.635 / 8019 

# DOOR HARDWARE

## Lever handle greenteQ stainless steel

### greenteQ Lever handle DG 59.ER.ORS.LT

greenteQ lever handle DG 59.ER.ORS.LT; for 8 mm square spindle; lever fixed movable on metal base, with spring mechanism; invisible fixing; stainless steel matt brushed.

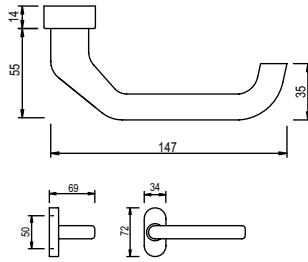

Material	Surface	Variants	Square spindle	PU	VBH Article-No.
Stainless steel	matt brushed	without cams	for 8 mm	1 pc.	316.631 / 6500 

### greenteQ Lever handle DG 60.ER.ORS.LT

greenteQ lever handle DG 60.ER.ORS.LT; for 8 mm square spindle; lever fixed movable on metal base, with spring mechanism; invisible fixing; stainless steel matt brushed.

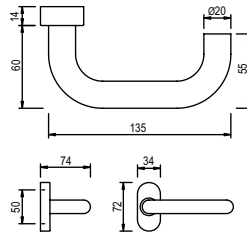

Material	Surface	Variants	Square spindle	PU	VBH Article-No.
Stainless steel	matt brushed	without cams	for 8 mm	1 pc.	987.209 / 6500 

### greenteQ Lever handle DG 60V.ER.ORS.LT

greenteQ lever handle DG 60V.ER.ORS.LT; for 8 mm square spindle; lever fixed movable on metal base, with spring mechanism; invisible fixing; stainless steel matt brushed.

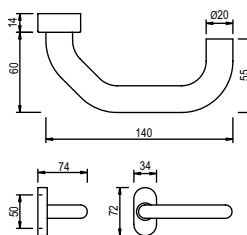

Material	Surface	Variants	Square spindle	PU	VBH Article-No.
Stainless steel	matt brushed	without cams	for 8 mm	1 pc.	995.525 / 6500 

### greenteQ Lever handle DG 60A.ER.ORS.LT

greenteQ lever handle DG 60A.ER.ORS.LT; for 8 mm square spindle; lever fixed movable on metal base, with spring mechanism; invisible fixing; stainless steel matt brushed.

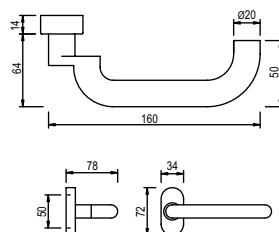

Material	Surface	Variants	Square spindle	PU	VBH Article-No.
Stainless steel	matt brushed	without cams	for 8 mm	1 pc.	312.866 / 6500 

# DOOR HARDWARE

## Lever handle greenteQ stainless steel

### greenteQ Lever handle DG 61.ER.ORS.LT

greenteQ lever handle DG 61.ER.ORS.LT; for 8 mm square spindle; lever fixed movable on metal base, with spring mechanism; invisible fixing; aluminium.

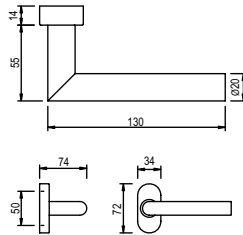

Material	Surface	Variants	Square spindle	PU	VBH Article-No.
Stainless steel	matt brushed	without cams	for 8 mm	1 pc.	987.213 / 6500 

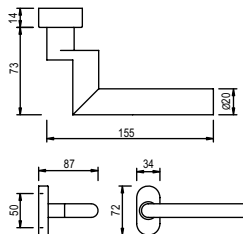

### greenteQ Lever handle DG 61A.ER.ORS.LT

greenteQ lever handle DG 61A.ER.ORS.LT; for 8 mm square spindle; lever fixed movable on metal base, with spring mechanism; invisible fixing; aluminium.



Material	Surface	Variants	Square spindle	PU	VBH Article-No.
Stainless steel	matt brushed	without cams	for 8 mm	1 pc.	381.892 / 6500 

### greenteQ Square spindle

Material	Surface	Dimension	VBH Article-No.
Steel	galvanized	8 x 60 mm	898.295 / 0060 
Steel	galvanized	8 x 70 mm	898.295 / 0070 
Steel	galvanized	8 x 80 mm	898.295 / 0080 



### greenteQ Half square spindle 8/10

Material	Surface	Dimension	VBH Article-No.
Steel	galvanized	8/10 x 70 mm	375.275 / 4010 



# DOOR HARDWARE

## Sliding rosettes greenteQ Stainless steel

### greenteQ Sliding rosette PZ oval 6 mm ER

greenteQ rosettes for entrance doors, to combine with pull handles and lever handles.  
greenteQ sliding rosette PZ oval 6 mm ER stainless steel; for profile cylinder; height of edge 6 mm; stainless steel matt brushed.

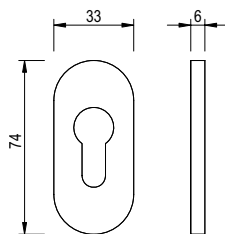

**Technical data:**

- Keyhole: PZ
- Door thickness: -
- Screws: exclusive
- Packaging unit: 10 pieces

Material	Surface	Height of edge	PU	VBH Article-No.
Stainless steel	matt brushed	6 mm	10 pieces	359.542 / 6500 

### greenteQ Sliding rosette oval 9 mm ER

greenteQ rosettes for entrance doors, to combine with pull handles and lever handles.  
greenteQ sliding rosette oval 9 mm ER stainless steel; for profile cylinder; height of edge 9 mm; stainless steel matt brushed.

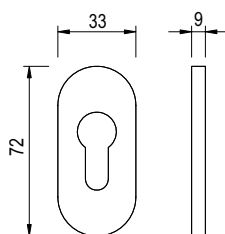

**Technical data:**

- Keyhole: PZ
- Door thickness: -
- Screws: exclusive
- Packaging unit: 10 pieces

Material	Surface	Height of edge	PU	VBH Article-No.
Stainless steel	matt brushed	9 mm	10 pieces	354.412 / 6500 

### greenteQ Sliding rosette ZA oval 14 mm ER

greenteQ rosettes for entrance doors, to combine with pull handles and lever handles.  
greenteQ sliding rosette ZA oval 14 mm ER, with cylinder cover; for profile cylinder; height of edge 14 mm; for cylinder protrusion 5 - 10 mm; stainless steel matt brushed.

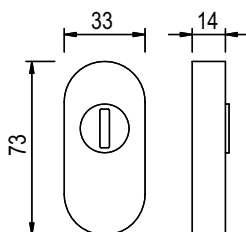

**Technical data:**

- Keyhole: PZ
- Door thickness: -
- Screws: exclusive
- Packaging unit: 10 pieces

Material	Surface	Height of edge	PU	VBH Article-No.
Stainless steel	matt brushed	14 mm	10 pieces	359.794 / 6500 

# DOOR HARDWARE

## Sliding rosettes greenteQ Stainless steel

### greenteQ Sliding rosette PZ oval 9 mm ER

greenteQ rosettes for entrance doors, to combine with pull handles and lever handles. greenteQ sliding rosette PZ oval 9 mm ER ; for profile cylinder; clip on; height of edge 9 mm; stainless steel matt brushed.

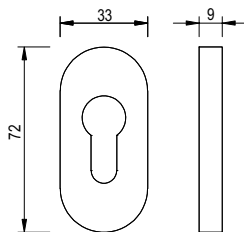

**Technical data:**

- Keyhole: PZ
- Door thickness: -
- Screws: exclusive
- Packaging unit: 10 pieces

Material	Surface	Height of edge	PU	VBH Article-No.
Stainless steel	matt brushed	9 mm	10 pieces	971.807 / 6500 

### greenteQ Sliding rosette PZ 10 mm ER

greenteQ rosette for entrance doors, to combine with pull handles and lever handles. greenteQ sliding rosette PZ 10 mm ER for profile cylinders projecting out of the door. They will be protected by greenteQ sliding rosette. Height of edge 10 mm; stainless steel matt brushed.

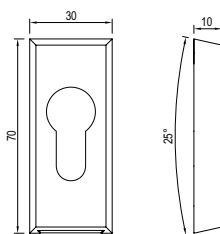

- **Technical data:** Keyhole: PZ
- Packaging unit: 10 pieces

Material	Surface	Height of edge	PU	VBH Article-No.
Stainless steel	matt brushed	10 mm	10 pieces	402.939 / 6500 

# DOOR HARDWARE

## Pull handles greenteQ Stainless steel

### greenteQ Pull handle TG 10.ER.GS

greenteQ stainless steel pull handles, for single-sided or pairwise use, on interior and exterior doors.

greenteQ pull handle TG 10.ER.GS; with straight stilts; diameter of handle bar 32 mm; diameter of stilts 25 mm; fixing system BA 15 not included; stainless steel matt brushed.

Material	Surface	Dimension Axis A	Length L	VBH Article-No.
Stainless steel	matt brushed	210 mm	330 mm	374.333 / 6500
Stainless steel	matt brushed	300 mm	400 mm	320.345 / 6500
Stainless steel	matt brushed	300 mm	500 mm	318.654 / 6500
Stainless steel	matt brushed	400 mm	600 mm	332.109 / 6500
Stainless steel	matt brushed	560 mm	800 mm	332.111 / 6500
Stainless steel	matt brushed	700 mm	1,000 mm	332.113 / 6500
Stainless steel	matt brushed	900 mm	1,200 mm	332.114 / 6500
Stainless steel	matt brushed	1,000 mm	1,400 mm	332.116 / 6500
Stainless steel	matt brushed	1,200 mm	1,600 mm	332.118 / 6500
Stainless steel	matt brushed	1,300 mm	1,800 mm	332.119 / 6500

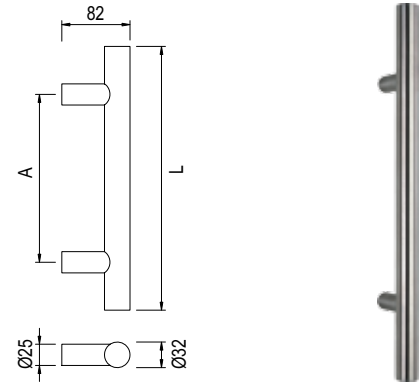

### greenteQ Pull handle TG 10.ER.GS with 45° stilts

greenteQ stainless steel pull handles, for single-sided or pairwise use, on interior and exterior doors.

greenteQ pull handle TG 10.ER.GS; with 45° angle stilts; diameter of handle bar 32 mm; diameter of stilts 25 mm; fixing system BA 15 not included; stainless steel matt brushed.

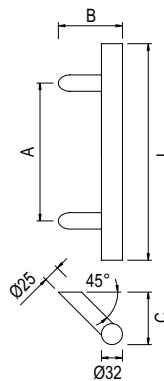

Material	Surface	Dimension Axis A	Length L	Dimension B	Dimension C	VBH Article-No.
Stainless steel	matt brushed	210 mm	330 mm	100 mm	80 mm	374.334 / 6500
Stainless steel	matt brushed	300 mm	400 mm	100 mm	80 mm	344.713 / 6500
Stainless steel	matt brushed	300 mm	500 mm	100 mm	80 mm	344.715 / 6500
Stainless steel	matt brushed	400 mm	600 mm	100 mm	80 mm	344.716 / 6500
Stainless steel	matt brushed	560 mm	800 mm	100 mm	80 mm	344.718 / 6500
Stainless steel	matt brushed	700 mm	1,000 mm	100 mm	80 mm	344.723 / 6500
Stainless steel	matt brushed	900 mm	1,200 mm	100 mm	80 mm	344.727 / 6500
Stainless steel	matt brushed	1,000 mm	1,400 mm	100 mm	80 mm	374.335 / 6500
Stainless steel	matt brushed	1,200 mm	1,600 mm	100 mm	80 mm	374.336 / 6500
Stainless steel	matt brushed	1,300 mm	1,800 mm	100 mm	80 mm	374.337 / 6500

# DOOR HARDWARE

## Pull handles greenteQ Stainless steel

### greenteQ Pull handle TG 10.ER.GS with 45° extended stilts

greenteQ stainless steel pull handles, for single-sided or pairwise use, on interior and exterior doors.  
greenteQ pull handle TG 10.ER.GS; with 45° angle, extended stilts; diameter of handle bar 32 mm; diameter of stilts 25 mm; fixing system BA 15 not included; stainless steel matt brushed.

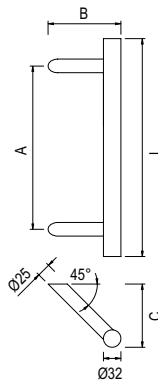

Material	Surface	Dimension Axis A	Length L	Dimension B	Dimension C	VBH Article-No.
Stainless steel	matt brushed	210 mm	330 mm	108 mm	90 mm	398.486 / 6500
Stainless steel	matt brushed	300 mm	400 mm	136 mm	116 mm	380.855 / 6500
Stainless steel	matt brushed	300 mm	400 mm	108 mm	90 mm	398.487 / 6500
Stainless steel	matt brushed	300 mm	500 mm	108 mm	90 mm	398.488 / 6500
Stainless steel	matt brushed	400 mm	600 mm	136 mm	116 mm	380.856 / 6500
Stainless steel	matt brushed	400 mm	600 mm	108 mm	90 mm	398.489 / 6500
Stainless steel	matt brushed	560 mm	800 mm	108 mm	90 mm	398.490 / 6500
Stainless steel	matt brushed	700 mm	1,000 mm	108 mm	90 mm	398.491 / 6500
Stainless steel	matt brushed	900 mm	1,200 mm	108 mm	90 mm	398.492 / 6500
Stainless steel	matt brushed	1,000 mm	1,400 mm	108 mm	90 mm	398.493 / 6500
Stainless steel	matt brushed	1,200 mm	1,600 mm	108 mm	90 mm	398.494 / 6500
Stainless steel	matt brushed	1,300 mm	1,800 mm	108 mm	90 mm	398.495 / 6500

### greenteQ Pull handle TG 11.ER.GS with 45° stilts

greenteQ stainless steel pull handles, for single-sided or pairwise use, on interior and exterior doors.  
greenteQ pull handle TG 11.ER.GS; with milled points with 45° angle stilts; diameter of handle bar 32 mm; diameter of stilts 25 mm; fixing system BA 15 not included; stainless steel matt brushed.

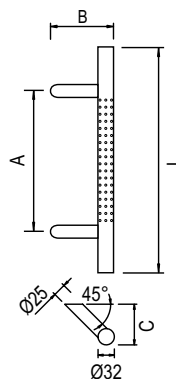

Material	Surface	Dimension Axis A	Length L	Dimension B	Dimension C	VBH Article-No.
Stainless steel	matt brushed	300 mm	400 mm	100 mm	80 mm	381.614 / 6500
Stainless steel	matt brushed	300 mm	500 mm	100 mm	80 mm	377.414 / 6500
Stainless steel	matt brushed	400 mm	600 mm	100 mm	80 mm	381.615 / 6500

# DOOR HARDWARE

## Pull handles greenteQ Stainless steel

### greenteQ Pull handle TG 12.ER

greenteQ stainless steel pull handles, for single-sided or pairwise use, on interior and exterior doors.

greenteQ pull handle TG 12.ER; with straight stilts; diameter of handle bar 32 mm; diameter of stilts 25 mm; fixing system BA 15 not included; stainless steel matt brushed.

Material	Surface	Dimension Axis A	Length L	VBH Article-No.
Stainless steel	matt brushed	300 mm	400 mm	381.451 / 6500
Stainless steel	matt brushed	695 mm	800 mm	381.450 / 6500

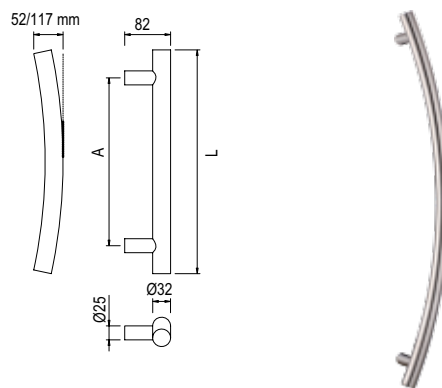

### greenteQ Pull handle TG 12.ER with 45° stilts

greenteQ stainless steel pull handles, for single-sided or pairwise use, on interior and exterior doors.

greenteQ pull handle TG 12.ER; with 45° angle stilts; diameter of handle bar 32 mm; diameter of stilts 25 mm; fixing system BA 15 not included; stainless steel matt brushed.

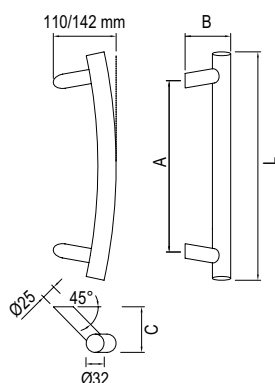

Material	Surface	Dimension Axis A	Length L	Dimension B	Dimension C	VBH Article-No.
Stainless steel	matt brushed	300 mm	400 mm	110 mm	78 mm	388.438 / 6500
Stainless steel	matt brushed	560 mm	800 mm	142 mm	78 mm	388.439 / 6500

### greenteQ Pull handle TG 10.ER.GKL

greenteQ stainless steel pull handles, for single-sided or pairwise use, on interior and exterior doors.

greenteQ pull handle TG 10.ER.GB; diameter of handle 32 mm; dimension 300 mm or 350 mm; fixing system BA 15 not included; stainless steel matt brushed.

Material	Surface	Dimension Axis A	Length L	VBH Article-No.
Stainless steel	matt brushed	300 mm	332 mm	312.885 / 6500
Stainless steel	matt brushed	350 mm	382 mm	312.886 / 6500

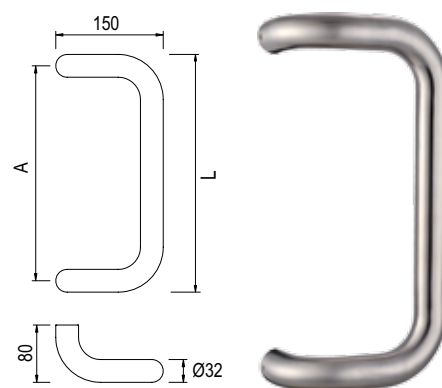





# DOOR HARDWARE

## Pull handles greenteQ Stainless steel

### greenteQ Pull handle TG 10.ER.GKW

greenteQ stainless steel pull handles, for single-sided or pairwise use, on interior and exterior doors.

greenteQ pull handle TG 10.ER.GB; diameter of handle 32 mm; dimension 300 mm or 350 mm; fixing system BA 15 not included; stainless steel matt brushed.

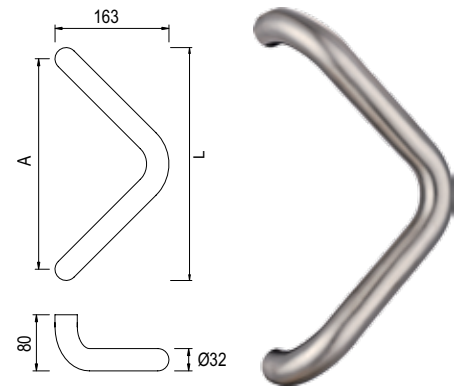

Material	Surface	Dimension Axis A	Length L	VBH Article-No.
Stainless steel	matt brushed	300 mm	332 mm	312.887 / 6500 
Stainless steel	matt brushed	350 mm	382 mm	312.890 / 6500 



### greenteQ Pull handle TG 10.ER.GKH

greenteQ stainless steel pull handles, for single-sided or pairwise use, on interior and exterior doors.

greenteQ pull handle TG 10.ER.GB; diameter of handle 32 mm; dimension 300 mm or 350 mm; fixing system BA 15 not included; stainless steel matt brushed.

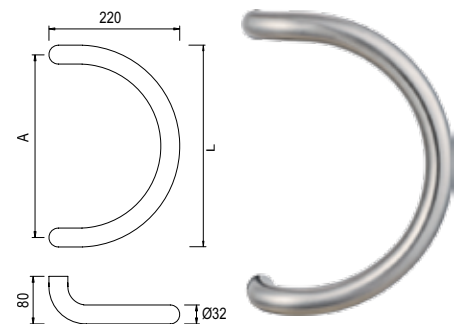

Material	Surface	Dimension Axis A	Length L	VBH Article-No.
Stainless steel	matt brushed	300 mm	332 mm	312.894 / 6500 
Stainless steel	matt brushed	350 mm	382 mm	312.896 / 6500 



### greenteQ Pull handle TG 10.ER.GB

greenteQ stainless steel pull handles, for single-sided or pairwise use, on interior and exterior doors.

greenteQ pull handle TG 10.ER.GB; diameter of handle 32 mm; dimension 300 mm or 350 mm; fixing system BA 15 not included; stainless steel matt brushed.

Material	Surface	Dimension Axis A	Length L	VBH Article-No.
Stainless steel	matt brushed	300 mm	332 mm	318.655 / 6500 
Stainless steel	matt brushed	350 mm	382 mm	318.656 / 6500 

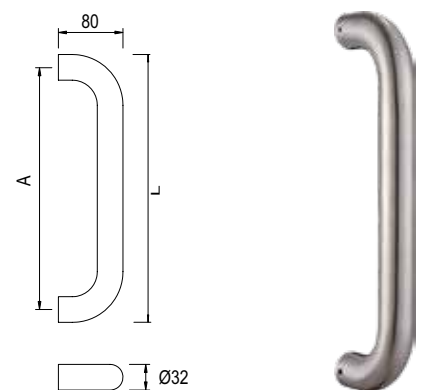

# DOOR HARDWARE

## Pull handles greenteQ Stainless steel

### greenteQ Fixing system BA 15.EU H/K/A

greenteQ pull handle fixations for a solid and durable mounting of the the pull handles.  
greenteQ pull handle fixing system BA 15.EU.H/K/A; for single-sided, invisible fixing on wooden-, PVC- and aluminium doors; bore diameter 10 mm; length of thread 20, 25, 30, 35, 45 or 55 mm. For 1 fixing point for a door handle 2 pcs needed.



#### Technical data:

- Fixing of handle: single-sided
- Bore diameter: 10 mm
- For door handles: TG 10... / TG 11... / TG 12...

Material	Length of thread	Door width	PU	VBH Article-No.
Galvanized steel	20 mm	-	1 pc.	381.257 / 0000
Galvanized steel	25 mm	-	1 pc.	382.975 / 0000
Galvanized steel	30 mm	-	1 pc.	381.258 / 0000
Galvanized steel	35 mm	-	1 pc.	381.259 / 0000
Galvanized steel	45 mm	-	1 pc.	381.260 / 0000
Galvanized steel	55 mm	-	1 pc.	383.289 / 0000
Galvanized steel	60 mm	-	1 pc.	398.057 / 0000
Galvanized steel	65 mm	-	1 pc.	398.058 / 0000

### greenteQ Fixing system BA 15.EU.H

greenteQ pull handle fixations for a solid and durable mounting of the the pull handles.  
greenteQ pull handle fixing system BA 15.EU.H; with Rampa-bushing; for single-sided, invisible fixing on wooden doors. For 1 fixing point for a door handle 2 pcs needed.

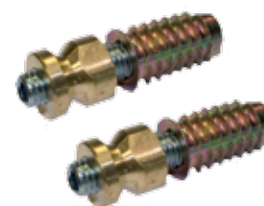

#### Technical data:

- Fixing of handle: single-sided
- Bore diameter: 10,7 - 11,0 mm
- For door handles: TG 10... / TG 11... / TG 12...

Material	Length of thread	Door width	PU	VBH Article-No.
Galvanized steel / Brass	14.5 x 25 mm	-	1 set	385.334 / 0002

### greenteQ Fixing system BA 15.ES.H/K/A

greenteQ pull handle fixations for a solid and durable mounting of the the pull handles.  
greenteQ pull handle fixing system BA 15.ES.H/K/A; for single-sided fixing through-fixing on wooden-, PVC- and aluminium doors; door thickness to 80 mm. For a door handle with two fastening points.



#### Technical data:

- Fixing of handle: single-sided
- Bore diameter: M8
- For door handles: TG 10... / TG 11... / TG 12...

Material	Door width	PU	VBH Article-No.
Stainless steel / Galvanized steel / Brass	to 80mm	1 set	312.937 / 0000
Stainless steel / Galvanized steel / Brass	95 mm	1 set	999.990 / 2167



# DOOR HARDWARE



## Pull handles greenteQ Stainless steel

### greenteQ Fixing system BA 15.PR.H/K/A

greenteQ pull handle fixations for a solid and durable mounting of the the pull handles.  
greenteQ pull handle fixing system BA 15.PR.H/K/A; for pairwise fixing on wooden-, PVC- and aluminium doors; door thickness up to 80 mm. For 1 pair handles with 4 fixing points.

**Technical data:**

- Fixing of handle: in pairs
- Bore dimension: M8

Material	Door width	PU	VBH Article-No.
Galvanized steel / Brass	80 mm	1 set	385.334 / 0001 
Galvanized steel / Brass	95 mm	1 set	999.990 / 2168 

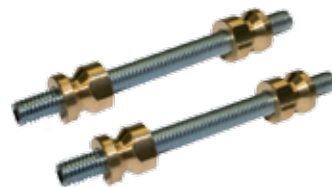

### greenteQ Fixing system BA 15.ES.G

greenteQ pull handle fixations for a solid and durable mounting of the the pull handles.  
greenteQ pull handle fixing system BA 15.ES.G; for single-sided, through-fixing on glass door;  
bore diameter 13 mm; glass thickness 8 - 12 mm. For 1 handle with 2 fixing points.

**Technical data:**

- Fixing of handle: single-sided, through-fixing
- Bore diameter: 13 mm
- For door handles: TG 10... / TG 11... / TG 12...

Material	Door width	PU	VBH Article-No.
Galvanized steel / Brass / Plastic	8-12	1 set	385.333 / 0002 



### greenteQ Fixing system BA 15.PR.G

greenteQ pull handle fixations for a solid and durable mounting of the the pull handles.  
greenteQ pull handle fixing system BA 15.PR.G; for pairwise fixing on glass doors; bore diameter 13 mm; glass thickness 8 - 12 mm. For 1 pair of handles with 4 fixing points.

**Technical data:**

- Fixing of handle: in pairs
- Bore diameter: 13 mm

Material	Door width	PU	VBH Article-No.
Galvanized steel / Brass / Plastic	8-12	1 set	385.333 / 0001 



### greenteQ Thread insert BA 15.M8

Thread insert with thread M8.

Material	Length	Door width	PU	VBH Article-No.
Brass	15 mm	-	1 pc.	379.183 / 0000 



# DOOR HARDWARE

## Pull handles greenteQ stainless steel

### greenteQ Pull handle TG 189.ER.GKS

greenteQ stainless steel pull handles, for single-sided or pairwise use, on interior and exterior doors.

greenteQ pull handle TG 189.ER.GKS; diameter of handle 27 mm; total length 320 mm; dimension 210 mm; fixing set No. 5 or No. 7 not included; stainless steel matt brushed.

Material	Surface	Dimension Axis A	Length L	VBH Article-No.
Stainless steel	matt brushed	210 mm	320 mm	315.387 / 6500 

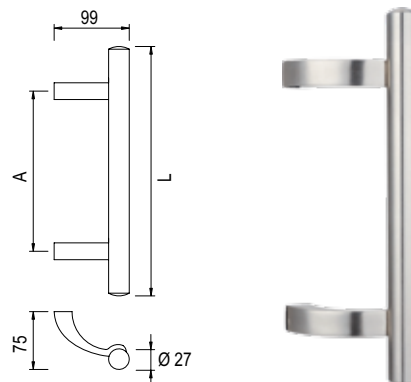

### greenteQ Pull handle TG 191.ER.GKS

greenteQ stainless steel pull handles, for single-sided or pairwise use, on interior and exterior doors.

greenteQ pull handle TG 191.ER.GKS; diameter of handle 27 mm; total length 315 mm; dimension 210 mm; fixing set No. 5 or No. 7 not included; stainless steel matt brushed.

Material	Surface	Dimension Axis A	Length L	VBH Article-No.
Stainless steel	matt brushed	210 mm	315 mm	315.388 / 6500 

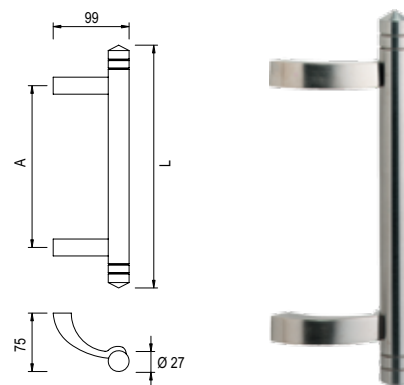

### greenteQ Fixing set no. 5

greenteQ pull handle fixations for a solid and durable mounting of the pull handles. greenteQ fixing set no. 5 for pull handle; for single-sided, invisible fixing on wooden- or PVC-doors; dimension of thread 8 x 35 mm.

For 1 handle with 2 fixing points.

#### Technical data:

- Fixing of handle: single-sided
- For pull handles: TG 189.ER.GKS / TG 191.ER.GKS

Material	Dimension	PU	VBH Article-No.
Galvanized steel	8 x 35 mm	1 set	360.377 / 0000 

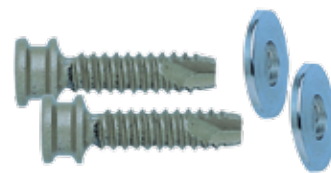

### greenteQ Fixing set no. 7

greenteQ pull handle fixations for a solid and durable mounting of the pull handles. greenteQ fixing set no. 7 for pull handles; for single-sided, invisible fixing on aluminium doors; dimension of thread M8 x 30 mm.

For 1 handle with 2 fixing points.

#### Technical data:

- Fixing of handle: single-sided
- For pull handles: TG 189.ER.GKS / TG 191.ER.GKS

Material	Dimension	PU	VBH Article-No.
Galvanized steel	M8 x 30 mm	1 set	360.378 / 0000 

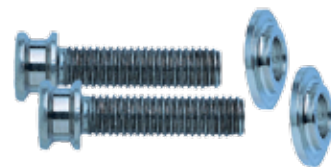

# DOOR HARDWARE

## Pull handle systems greenteQ

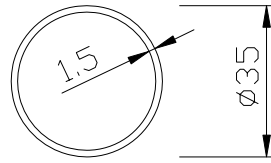

### greenteQ Stainless steel round tube without stilts

greenteQ pull handle system to manufacture pull handles in individual lengths.  
greenteQ pull handle system; round tube; diameter of pipe 35 mm; length of tube 2,000 mm or 3,000 mm; without stilts; stainless steel matt brushed.



**Technical data:**

- Diameter of tube: 35 mm
- Material thickness: 1.5 mm

Material	Surface	Length L	PU	VBH Article-No.
Stainless steel	matt brushed	2,000 mm	1 piece	321.924 / 6500 
Stainless steel	matt brushed	3,000 mm	1 piece	959.585 / 6500 

### greenteQ Galvanized steel tube square

greenteQ pull handle system to manufacture pull handles in individual lengths.  
greenteQ pull handle system of stainless steel; steel reinforcement profile 20 x 20 x 2 mm, length of tube 2,000 mm or 3,000 mm, galvanized steel; spacing sleeve round with fixing screw, diameter 31.5 mm, plastic.

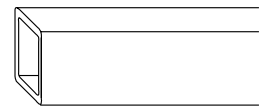
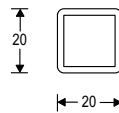

Material	Surface	Length L	PU	VBH Article-No.
Steel	galvanized	2,000 mm	1 piece	372.444 / 4010 
Steel	galvanized	3,000 mm	1 piece	959.586 / 4010 

### greenteQ Spacing sleeve round

With fixing screw. For steel reinforcement profile, mount at an interval of 350 mm.

Material	PU	VBH Article-No.
Plastic	100 pieces	959.592 / 0000 

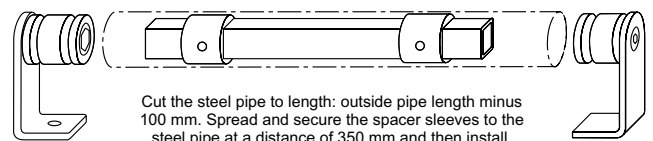
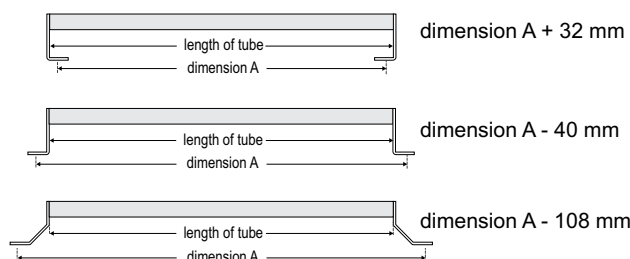
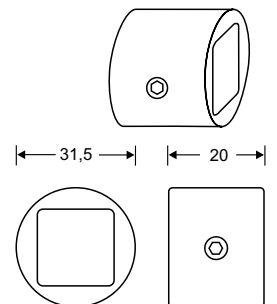

Accessories for door handles reinforcing, which are used on the heavily used doors or have a measure A between 1.500 - 2.100 mm.

# DOOR HARDWARE

## Pull handle systems greenteQ

### greenteQ Straight bracket

greenteQ pull handle system to manufacture pull handles in individual lengths.  
greenteQ pull handle system; straight bracket; inward angled mounting strap; stainless steel matt brushed.

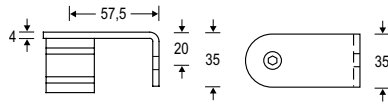



Material	Surface	Direction	PU	VBH Article-No.
Stainless steel	matt brushed	straight	1 piece	959.590 / 6500 

### greenteQ 45° angle bracket

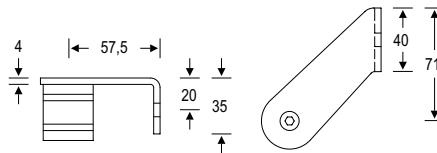
greenteQ pull handle system to manufacture pull handles in individual lengths.  
greenteQ pull handle system; 45° angle bracket; inward angled mounting strap; stainless steel matt brushed.





Material	Surface	Direction	PU	VBH Article-No.
Stainless steel	matt brushed	left	1 piece	993.943 / 6501 
Stainless steel	matt brushed	right	1 piece	993.940 / 6502 

### greenteQ Bracket fastening

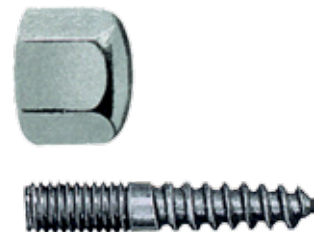
greenteQ pull handle system to manufacture pull handles in individual lengths.  
greenteQ pull handle system; bracket fastening; dome nut of stainless steel M8; steel stud for timber fixing M8 x 40 mm, blank.



Description	Material	Surface	PU	VBH Article-No.
Steel stud for timber fixing	Steel	blank	1 piece	864.494 / 0000 
Dome nut	Stainless steel	matt brushed	1 piece	355.667 / 6500 

# DOOR HARDWARE

## Lever handles for framed doors Stainless steel





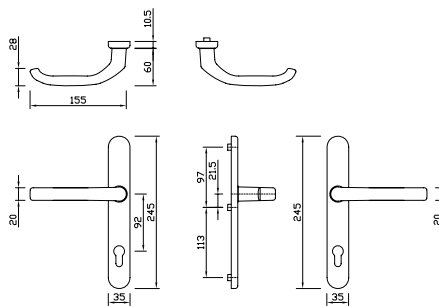

### greenteQ DG 58.ER.SS PZ 92

The greenteQ lever handle set for framed doors DG 58.ERL.SS PZ 92 is made of stainless steel and has a plate of 35 mm width. The lever handle set is PZ perforated with a distance of 92 mm. Lever handles are fixed/pivoted and have a spring mechanism. The greenteQ lever handle set for framed doors DG 58.ER.SS PZ 92 is prepared with an 8 mm square spindle. The outer lever handle has lugs on backplates and the fixing is made by means of invisible screw connection which needs a separate set of accessories (3 screws M6, 1 square spindle 8 mm).



Material	Surface	Square spindle	VBH Article-No.
Stainless steel	matt brushed	for 8 mm	391.931 / 6500 

### greenteQ Accessories DG 58.AL.SS

Door thickness	PU	VBH Article-No.
59 - 65 mm	1 set	391.961 / 5965 
64 - 70 mm	1 set	391.961 / 6470 
69 - 75 mm	1 set	391.961 / 6975 
74 - 80 mm	1 set	391.961 / 7480 
79 - 85 mm	1 set	391.961 / 7985 
89 - 95 mm	1 set	391.961 / 8995 



### greenteQ DG 58.ER.SSWB PZ 92

The greenteQ lever handle set for framed doors DG 58.ER.SSWB PZ 92 is made of stainless steel and has a plate of 35 mm width. The lever handle set is PZ perforated with a distance of 92 mm. The cranked handle fixed on the outer plate is mountable. The lever handle on the inner plate is fixed/pivoted and have a spring mechanism. The greenteQ lever handle set for framed doors DG 58.ER.SSWB PZ 92 is prepared with an 8 mm square spindle. The outer lever handle has lugs on the backplate and the fixing is made by means of invisible screw connection which needs a separate set of accessories (3 screws M6, 1 square spindle 8 mm).

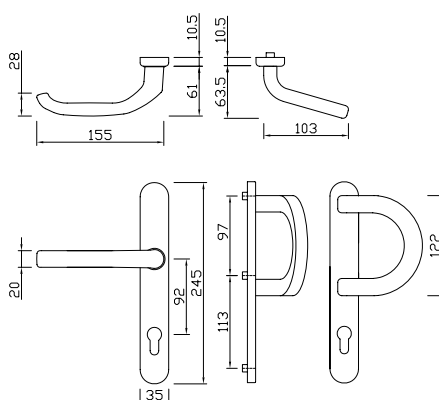

Material	Surface	Square spindle	VBH Article-No.
Stainless steel	matt brushed	for 8 mm	396.262 / 6500 

# DOOR HARDWARE

## Lever handles for framed doors Stainless steel



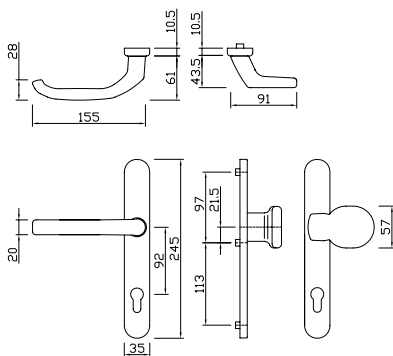

### greenteQ DG 58.ER.SSWK PZ 92

The greenteQ lever handle set for framed doors DG 58.ER.SSWK PZ 92 is made of stainless steel and has a plate of 35 mm width. The lever handle set is PZ perforated with a distance of 92 mm. The cranked knob fixed on the outer plate is mountable. The lever handle on the inner plate is fixed/pivoted and have a spring mechanism. The greenteQ lever handle set for framed doors DG 58.ER.SSWK PZ 92 is prepared with an 8 mm square spindle. The outer lever handle has lugs on the backplate and the fixing is made by means of invisible screw connection which needs a separate set of accessories (3 screws M6, 1 square spindle 8 mm).



Material	Surface	Square spindle	VBH Article-No.
Stainless steel	matt brushed	for 8 mm	396.261 / 6500 

### greenteQ Accessories DG 58.AL.SSW

Door thickness	PU	VBH Article-No.
59 - 65 mm	1 set	396.264 / 5965 
64 - 70 mm	1 set	396.264 / 6470 
69 - 75 mm	1 set	396.264 / 6975 
74 - 80 mm	1 set	396.264 / 7480 
79 - 85 mm	1 set	396.264 / 7985 



### greenteQ DG 58.ER.SS.IN PZ 92

The greenteQ lever handle for framed doors DG 58.ER.SS.IN PZ 92 is made of stainless steel, used as half set for inside and has a plate of 35 m width. The lever handle is PZ perforated with a distance 92 mm. The Lever handle is fixed/pivoted and has a spring mechanism. The greenteQ lever handle for framed doors DG 58.ER.SS.IN PZ 92 is prepared with an 8 mm square spindle. The fixing is made by means of invisible screw connection.

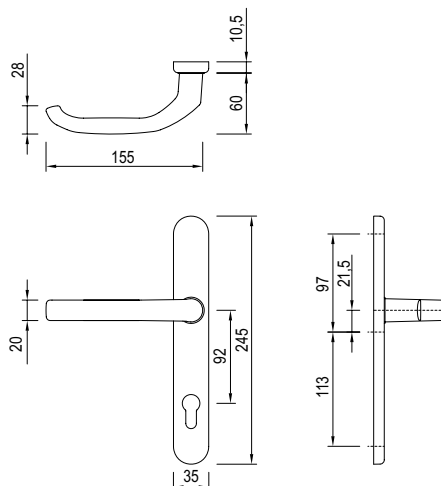

Material	Surface	Square spindle	VBH Article-No.
Stainless steel	matt brushed	for 8 mm	396.263 / 6500 





# DOOR HARDWARE

## Lever handles for framed doors Stainless steel

### greenteQ DG 58.ER.SS.AU PZ 92

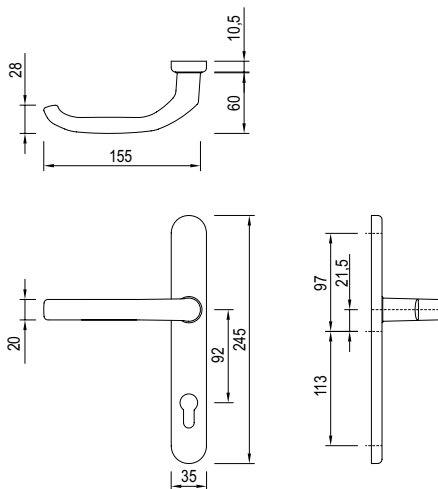
The greenteQ lever handle for framed doors DG 58.ER.SS.AU PZ 92 is made of stainless steel, used as half set for outside and has a plate of 35 mm width. The lever handle is PZ perforated with a distance 92 mm. The lever handle is fixed/pivoted and has a spring mechanism. The greenteQ lever handle for framed doors DG 58.ER.SS.AU PZ 92 is prepared with an 8 mm square spindle and has lugs on the backplate. The fixing is made by means of invisible screw connection.



Material	Surface	Square spindle	VBH Article-No.
Stainless steel	matt brushed	for 8 mm	397.582 / 6500 

### greenteQ DG 58.ER.SSB.AU PZ 92

The greenteQ lever handle for framed doors DG 58.AL.SSB.ER PZ 92 is made of stainless steel, used as half set for outside and has a plate of 35 mm width. The lever handle is PZ perforated with a distance 92 mm. The cranked handle fixed on the outer plate is mountable. The greenteQ lever handle for framed doors DG 58.ER.SSB.AU PZ 92 is prepared with an 8 mm square spindle and has lugs on the backplate. The fixing is made by means of invisible screw connection.

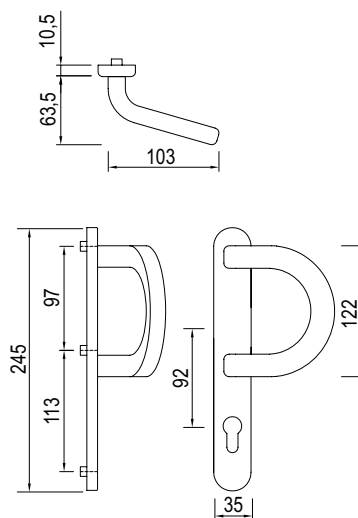

Material	Surface	Square spindle	VBH Article-No.
Stainless steel	matt brushed	for 8 mm	397.584 / 6500 

# DOOR HARDWARE

## Lever handles for framed doors Stainless steel

### greenteQ DG 58.ER.SSK.AU PZ 92

The greenteQ lever handle for framed doors DG 58.ER.SSK.AU PZ 92 is made of stainless steel, used as half set for outside und has a plate of 35 mm width. The lever handle is PZ perforated with a distance 92 mm. The cranked knob fixed on the outer plate is mountable.

The greenteQ lever handle for framed doors DG 58.ER.SSK.AU PZ 92 is prepared with an 8 mm square spindle and has lugs on the backplate. The fixing is made by means of invisible screw connection.

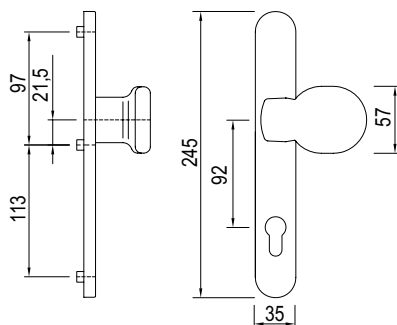
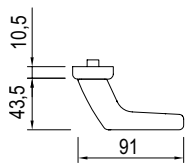

Material	Surface	Square spindle	VBH Article-No.
Stainless steel	matt brushed	for 8 mm	397.583 / 6500 

### greenteQ Drilling jig set

The greenteQ drilling jig set for lever handle sets is prepared for the fixing of lever handle sets with round roses and lever handle sets for framed doors with long plate. The drilling jig set includes four different paper templates for rose furniture with distances of BB / PZ 72 mm , WC 78 mm or PZ 92 mm as well as for lever handle sets for framed doors with 92 mm distance. The drilling jig is made of plastic, equipped with hardened bushes and will be delivered in one practical plastic box. The required guide pins and drills are included.

#### Content:

- 1. Drilling jig
- 2. Paper templates
  - for lever handle sets for framed doors PZ 92 with long plate
  - for lever handle sets on round rose WC 78 mm distance
  - for lever handle sets on round rose BB / PZ 72 mm distance
  - for security roses PZ 92 mm distance
- 3. Knurled screw M5
- 4. Guide pins
  - Ø 8 mm (for 8 mm square spindle aperture )
  - Ø 9 mm (for 9 mm square spindle aperture )
  - Ø 10 mm (for 10 mm square spindle aperture )
  - Ø 7 mm (for BB-Lock)
  - Ø 8 mm (for WC-Lock)
  - Ø 17 mm (for PZ-Lock)
- 5. Drills
  - Ø 9 mm
  - Ø 10.5 mm



Material	PU	VBH Article-No.
Plastic with hardened bushes	1 set	396.668 / 0000 

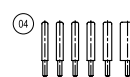
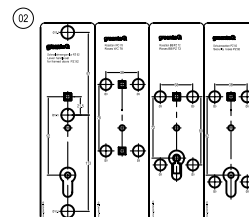
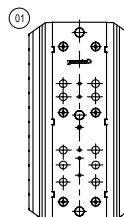

# DOOR HARDWARE

## Lever handle set for framed doors Aluminium

### greenteQ Lever handle set for framed doors DG 58.AL.SS PZ 92

The greenteQ lever handle set for framed doors DG 58.AL.SS PZ 92 is made of aluminium and has a plate of 35 mm width. The lever handle set is PZ perforated with a distance of 92 mm. Lever handles are fixed/pivoted and have a spring mechanism. The greenteQ lever handle set for framed doors DG 58.AL.SS is prepared with an 8 mm square spindle. The outer lever handle has lugs on backplates and the fixing is made by means of invisible screw connection which needs a separate set of accessories (3 screws M6, 1 square spindle 8 mm).

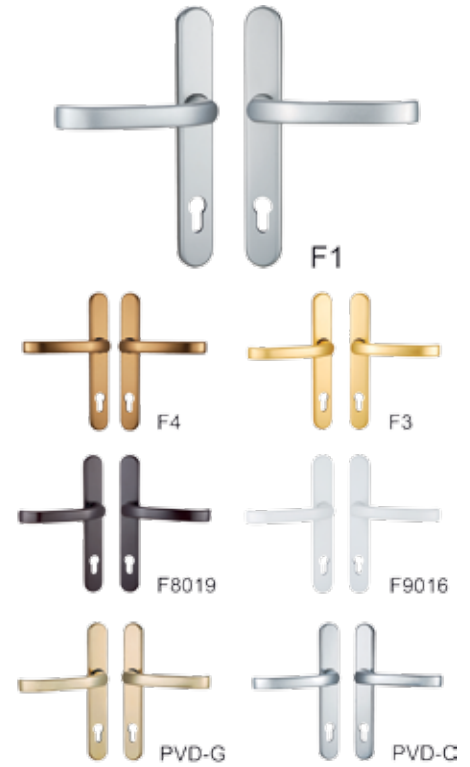
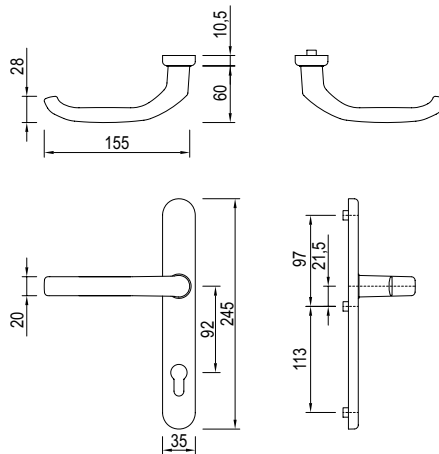

Surface	Colour code	Square spindle	VBH Article-No.
silver anodized	F1	for 8 mm	391.931 / 0100
gold anodized	F3	for 8 mm	391.931 / 0300
bronze anodized	F4	for 8 mm	391.931 / 0400
white coated	F9016	for 8 mm	391.931 / 1600
brown coated	F8019	for 8 mm	391.931 / 8019
PVD chrome polished	PVD-C	for 8 mm	391.931 / 4210
PVD gold polished	PVD-G	for 8 mm	391.931 / 7110

### greenteQ Accessories DG 58.AL.SS

Door thickness	PU	VBH Article-No.
59 - 65 mm	1 set	391.961 / 5965
64 - 70 mm	1 set	391.961 / 6470
69 - 75 mm	1 set	391.961 / 6975
74 - 80 mm	1 set	391.961 / 7480
79 - 85 mm	1 set	391.961 / 7985
89 - 95 mm	1 set	391.961 / 8995









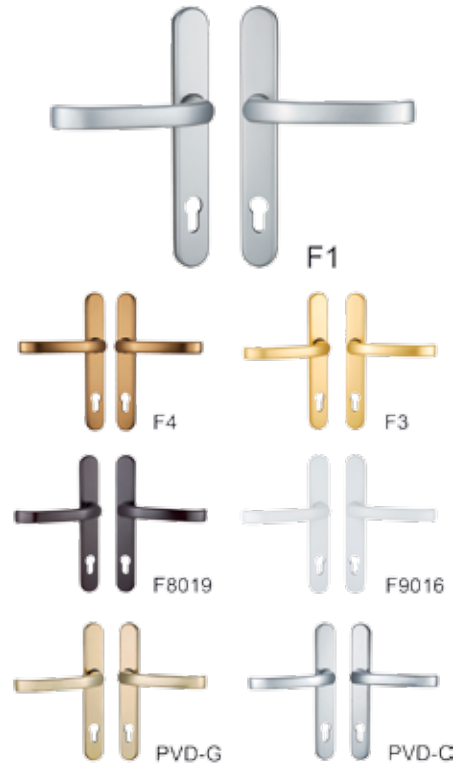
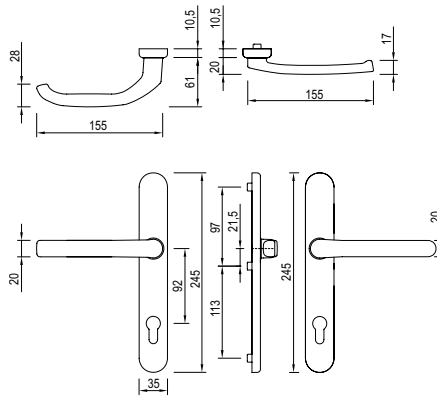

# DOOR HARDWARE

## Lever handle set for framed doors Aluminium

### greenteQ Lever handle set for framed doors DG 58.AL.SSN PZ 92





The greenteQ lever handle set for framed doors DG 58.AL.SSN PZ 92 is made of aluminium and has a plate of 35 mm width. The lever handle is PZ perforated with a distance of 92 mm. The lever handle on the outer plate is low. The lever handle on the inner plate is fixed/pivoted and has a spring mechanism. The greenteQ lever handle set for framed doors DG 58.AL.SSN PZ 92 is prepared with an 8 mm square spindle. The outer lever handle has lugs on backplates and the fixing is made by means of invisible screw connection which needs a separate set of accessories (3 screws M6, 1 square spindle 8 mm).



Surface	Colour code	Square spindle	VBH Article-No.
silver anodized	F1	for 8 mm	398.501 / 0100 
gold anodized	F3	for 8 mm	398.501 / 0300 
bronze anodized	F4	for 8 mm	398.501 / 0400 
white coated	F9016	for 8 mm	398.501 / 1600 
brown coated	F8019	for 8 mm	398.501 / 8019 
PVD chrome polished	PVD-C	for 8 mm	398.501 / 4210 
PVD gold polished	PVD-G	for 8 mm	398.501 / 7110 

### greenteQ Accessories DG 58.AL.SSN

3 screws M6, 1 square spindle 8 mm

Door thickness	PU	VBH Article-No.
59 - 65 mm	1 set	398.502 / 5965 
64 - 70 mm	1 set	398.502 / 6470 
69 - 75 mm	1 set	398.502 / 6975 
74 - 80 mm	1 set	398.502 / 7480 
79 - 85 mm	1 set	398.502 / 7985 



# DOOR HARDWARE

## Lever handle set for framed doors Aluminium

### greenteQ Lever handle set for framed doors DG 58.AL.SSWK PZ 92

The greenteQ lever handle set for framed doors DG 58.AL.SSWK PZ 92 is made of aluminium and has a plate of 35 mm width. The lever handle set is PZ perforated with a distance of 92 mm. The cranked knob fixed on the outer plate is mountable. The lever handle on the inner plate is fixed/pivoted and have a spring mechanism. The greenteQ lever handle set for framed doors DG 58.AL.SSWK PZ 92 is prepared with an 8 mm square spindle. The outer lever handle has lugs on the backplate and the fixing is made by means of invisible screw connection which needs a separate set of accessories (3 screws M6, 1 square spindle 8 mm).

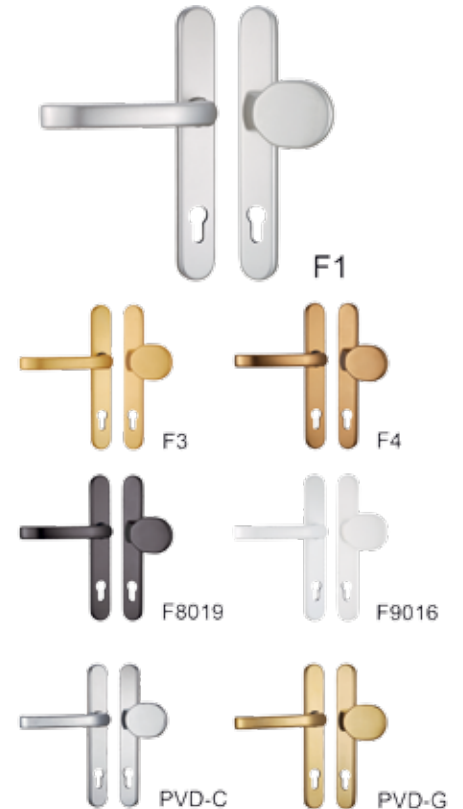
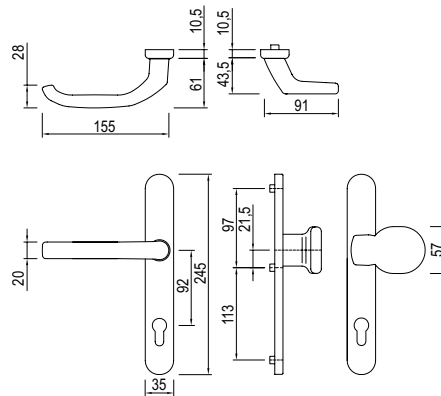

Surface	Colour code	Square spindle	VBH Article-No.
silver anodized	F1	for 8 mm	396.261 / 0100
gold anodized	F3	for 8 mm	396.261 / 0300
bronze anodized	F4	for 8 mm	396.261 / 0400
white coated	F9016	for 8 mm	396.261 / 1600
brown coated	F8019	for 8 mm	396.261 / 8019
PVD chrome polished	PVD-C	for 8 mm	396.261 / 4210
PVD gold polished	PVD-G	for 8 mm	396.261 / 7110

### greenteQ Lever handle set for framed doors DG 58.AL.SSWB PZ 92

The greenteQ lever handle set for framed doors DG 58.AL.SSWB PZ 92 is made of aluminium and has a plate of 35 mm width. The lever handle set is PZ perforated with a distance of 92 mm. The cranked handle fixed on the outer plate is mountable. The lever handle on the inner plate is fixed/pivoted and have a spring mechanism. The greenteQ lever handle set for framed doors DG 58.AL.SSWB PZ 92 is prepared with an 8 mm square spindle. The outer lever handle has lugs on the backplate and the fixing is made by means of invisible screw connection which needs a separate set of accessories (3 screws M6, 1 square spindle 8 mm).

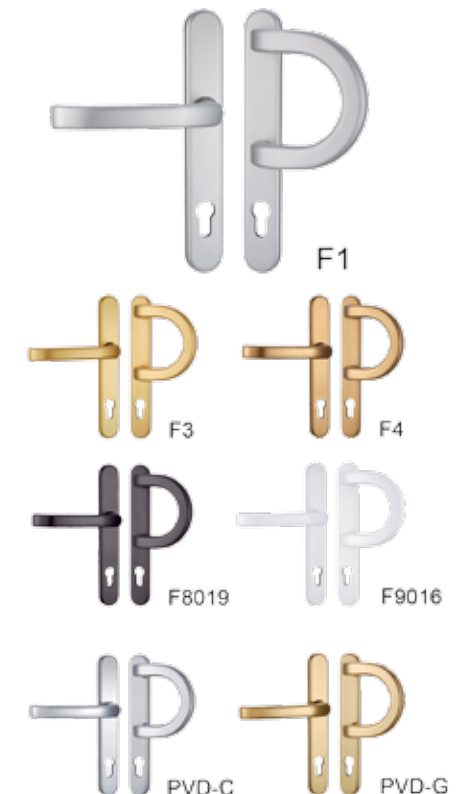
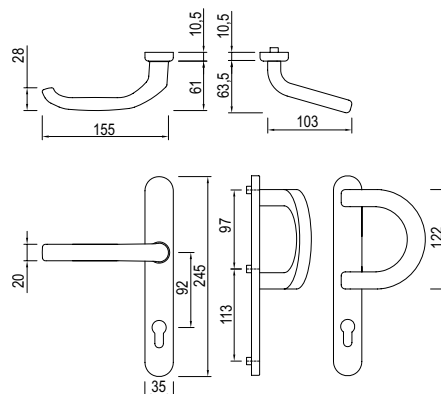





Surface	Colour code	Square spindle	VBH Article-No.
silver anodized	F1	for 8 mm	396.262 / 0100
gold anodized	F3	for 8 mm	396.262 / 0300
bronze anodized	F4	for 8 mm	396.262 / 0400
white coated	F9016	for 8 mm	396.262 / 1600
brown coated	F8019	for 8 mm	396.262 / 8019
PVD chrome polished	PVD-C	for 8 mm	396.262 / 4210
PVD gold polished	PVD-G	for 8 mm	396.262 / 7110

# DOOR HARDWARE

## Lever handle set for framed doors Aluminium

### greenteQ Accessories DG 58.AL.SSW







Door thickness	PU	VBH Article-No.
59 - 65 mm	1 set	396.264 / 5965 
64 - 70 mm	1 set	396.264 / 6470 
69 - 75 mm	1 set	396.264 / 6975 
74 - 80 mm	1 set	396.264 / 7480 
79 - 85 mm	1 set	396.264 / 7985 

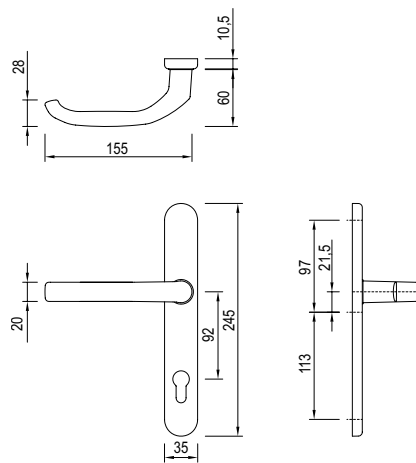

### greenteQ Lever handle for framed doors DG 58.AL.SS.IN PZ 92

The greenteQ lever handle for framed doors DG 58.AL.SS.IN PZ 92 is made of aluminium, used as half set for inside and has a plate of 35 mm width. The lever handle is PZ perforated with a distance of 92 mm. The lever handle is fixed/pivoted and has a spring mechanism. The greenteQ lever handle for framed doors DG 58.AL.SS.IN PZ 92 is prepared with an 8 mm square spindle. The fixing is made by means of invisible screw connection.



Surface	Colour code	Square spindle	VBH Article-No.
silver anodized	F1	for 8 mm	396.263 / 0100 
golden anodized	F3	for 8 mm	396.263 / 0300 
bronze anodized	F4	for 8 mm	396.263 / 0400 
white coated	F9016	for 8 mm	396.263 / 1600 
brown coated	F8019	for 8 mm	396.263 / 8019 
PVD chrome polished	PVD-C	for 8 mm	396.263 / 4210 
PVD gold polished	PVD-G	for 8 mm	396.263 / 7110 

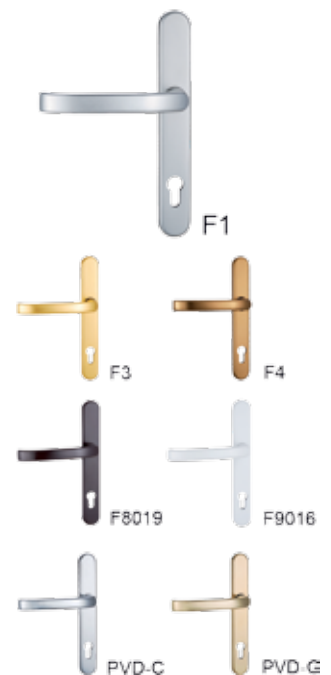

# DOOR HARDWARE

## Lever handle set for framed doors Aluminium

### greenteQ Lever handle for framed doors DG 58.AL.SS.AU PZ 92

The greenteQ lever handle for framed doors DG 58.AL.SS.AU PZ 92 is made of aluminium, used as half set for outside und has a plate of 35 mm width. The lever handle is PZ perforated with a distance 92 mm. The lever handle is fixed/pivoted and has a spring mechanism. The greenteQ lever handle for framed doors DG 58.AL.SS.AU PZ 92 is prepared with an 8 mm square spindle and has lugs on the backplate. The fixing is made by means of invisible screw connection.

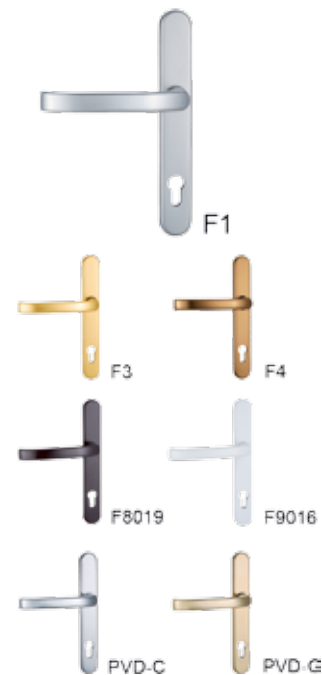
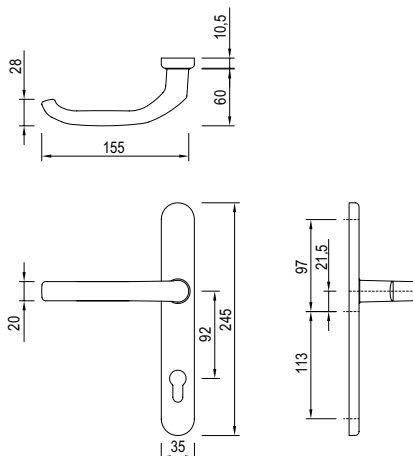

Surface	Colour code	Square spindle	VBH Article-No.
silver anodized	F1	for 8 mm	397.582 / 0100
golden anodized	F3	for 8 mm	397.582 / 0300
bronze anodized	F4	for 8 mm	397.582 / 0400
white coated	F9016	for 8 mm	397.582 / 1600
brown coated	F8019	for 8 mm	397.582 / 8019
PVD chrome polished	PVD-C	for 8 mm	397.582 / 4210
PVD gold polished	PVD-G	for 8 mm	397.582 / 7110

### greenteQ Lever handle for framed doors DG 58.AL.SSB.AU PZ 92

The greenteQ lever handle for framed doors DG 58.AL.SSB.AU PZ 92 is made of aluminium, used as half set for outside und has a plate of 35 mm width. The lever handle is PZ perforated with a distance 92 mm. The cranked handle fixed on the outer plate is mountable. The greenteQ lever handle for framed doors DG 58.AL.SSB.AU PZ 92 is prepared with an 8 mm square spindle and has lugs on the backplate. The fixing is made by means of invisible screw connection.

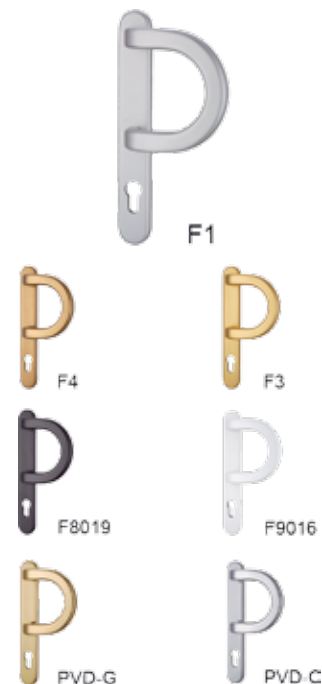
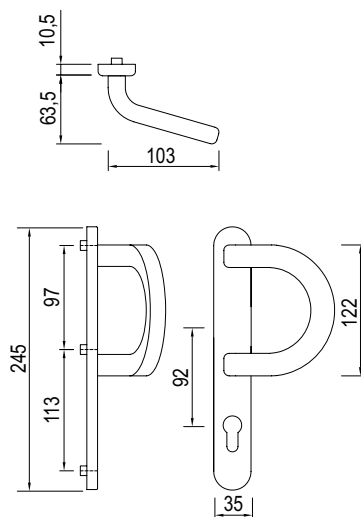

Surface	Colour code	Square spindle	VBH Article-No.
silver anodized	F1	for 8 mm	397.584 / 0100
golden anodized	F3	for 8 mm	397.584 / 0300
bronze anodized	F4	for 8 mm	397.584 / 0400
white coated	F9016	for 8 mm	397.584 / 1600
brown coated	F8019	for 8 mm	397.584 / 8019
PVD chrome polished	PVD-C	for 8 mm	397.584 / 4210
PVD gold polished	PVD-G	for 8 mm	397.584 / 7110





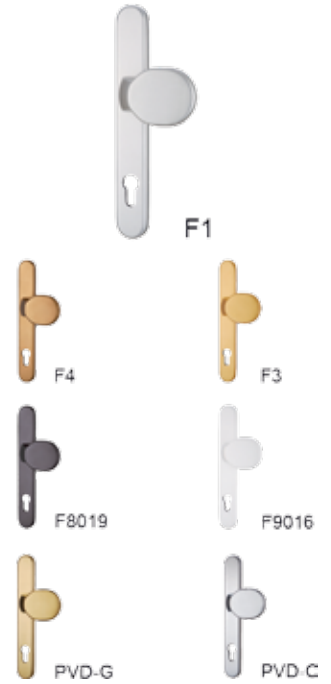
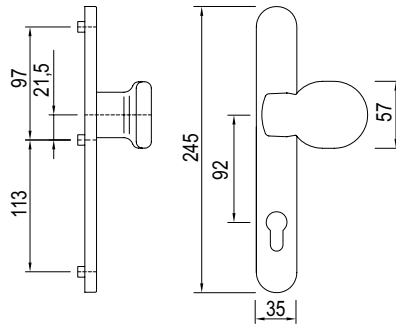
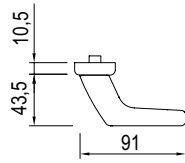

# DOOR HARDWARE

## Lever handle set for framed doors Aluminium

### greenteQ Lever handle for framed doors DG 58.AL.SSK.AU PZ 92

The greenteQ lever handle for framed doors DG 58.AL.SSK.AU PZ 92 is made of aluminium, used as half set for outside und has a plate of 35 mm width. The lever handle is PZ perforated with a distance 92 mm. The cranked knob fixed on the outer plate is mountable. The greenteQ lever handle for framed doors DG 58.AL.SSK.AU PZ 92 is prepared with an 8 mm square spindle and has lugs on the backplate. The fixing is made by means of invisible screw connection.



Surface	Colour code	Square spindle	VBH Article-No.
silver anodized	F1	for 8 mm	397.583 / 0100 
golden anodized	F3	for 8 mm	397.583 / 0300 
bronze anodized	F4	for 8 mm	397.583 / 0400 
white coated	F9016	for 8 mm	397.583 / 1600 
brown coated	F8019	for 8 mm	397.583 / 8019 
PVD chrome polished	PVD-C	for 8 mm	397.583 / 4210 
PVD gold polished	PVD-G	for 8 mm	397.583 / 7110 



# DOOR HARDWARE

## Lever handle set for framed doors Aluminium

### greenteQ Drilling jig set

The greenteQ drilling jig set for lever handle sets is prepared for the fixing of lever handle sets with round roses and lever handle sets for framed doors with long plate. The drilling jig set includes four different paper templates for rose furniture with distances of BB / PZ 72 mm , WC 78 mm or PZ 92 mm as well as for lever handle sets for framed doors with 92 mm distance. The drilling jig is made of plastic, equipped with hardened bushes and will be delivered in one practical plastic box. The required guide pins and drills are included.

#### Content:

- 1. Drilling jig
- 2. Paper templates
  - for lever handle sets for framed doors PZ 92 with long plate
  - for lever handle sets on round rose WC 78 mm distance
  - for lever handle sets on round rose BB / PZ 72 mm distance
  - for security roses PZ 92 mm distance
- 3. Knurled screw M5
- 4. Guide pins
  - Ø 8 mm (for 8 mm square spindle aperture )
  - Ø 9 mm (for 9 mm square spindle aperture )
  - Ø 10 mm (for 10 mm square spindle aperture )
  - Ø 7 mm (for BB-Lock)
  - Ø 8 mm (for WC-Lock)
  - Ø 17 mm (for PZ-Lock)
- 5. Drills
  - Ø 9 mm
  - Ø 10.5 mm



Material	PU	VBH Article-No.
Plastic with hardened bushes	1 set	396.668 / 0000 

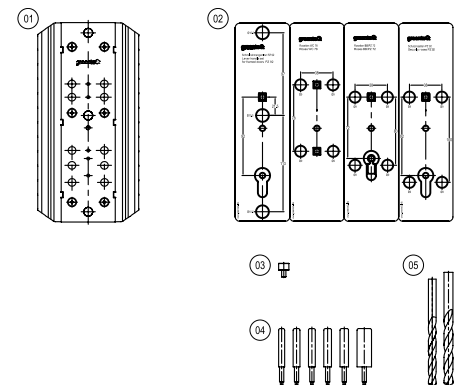

# DOOR HARDWARE

## Mortise locks

### greenteQ RR lock PZ

greenteQ mortise locks RR for frame doors are suitable for commercial and residential construction according to EN 12209:2003, Usage Class 3, as well as for use in public buildings. greenteQ mortise locks RR fulfil the terms, dimensions, requirements, tests and identification for mortise locks with latches and/or locking bolts of DIN 18251-2.











greenteQ mortise locks RR are characterised by high saw-through resistance through the use of two hardened and loosely mounted steel pins in the latch as well as the closed construction of the lock chamber, solidly bolted to the face plate. In addition, greenteQ mortise locks RR are equipped with a high-quality machined face plate with a thickness of 3 mm.

With a bolt extension of 20 mm – single-throw, the greenteQ mortise locks RR offer easy operation and a high level of protection. greenteQ mortise locks RR can be used on the left and right side, due to the reversible latch. The working height of the lock case is 15 mm. greenteQ mortise locks RR are preconfigured for profile cylinders and are certified in accordance with DIN 18252.

#### Technical data:

- Face plate material: Galvanised steel (high corrosion resistance)
- Bolt and latch material: Zink die-cast
- Lock case material: Sendzimir-galvanised sheet
- Follower material: Galvanised steel
- Latch: Right/left reversible
- Classification key according to EN 12209:2003:  
Backset 25 mm | 3 | M | 4 | 0 | 0 | F | 4 | H | A | 2 | 0 |  
Backset 35 - 55 mm | 3 | M | 4 | 0 | 0 | F | 6 | H | A | 2 | 0 |

Face plate	Backset	Follower	PU	VBH Article-No.
16 mm	25 mm	8 mm	1 pc.	396.433 / 6500 
16 mm	35 mm	8 mm	1 pc.	396.434 / 6500 
16 mm	40 mm	8 mm	1 pc.	397.327 / 6500 
16 mm	45 mm	8 mm	1 pc.	396.435 / 6500 
16 mm	55 mm	8 mm	1 pc.	396.436 / 6500 
20 mm	55 mm	8 mm	1 pc.	396.437 / 6500 
24 mm	25 mm	8 mm	1 pc.	397.751 / 6500 
24 mm	35 mm	8 mm	1 pc.	397.752 / 6500 

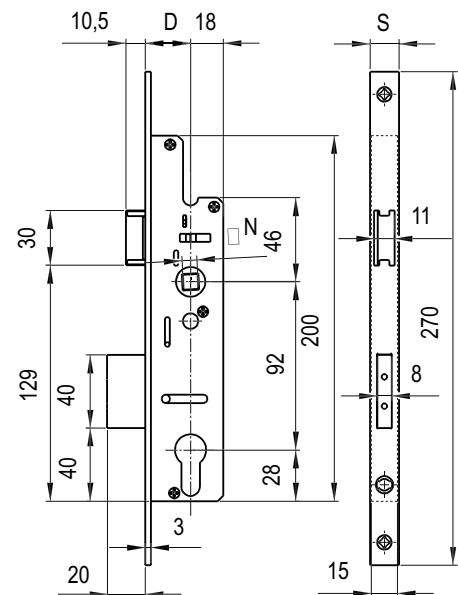

# DOOR HARDWARE

## Mortise locks

### greenteQ RR lock RF PZ

greenteQ mortise locks RF with rolling latches for swing doors are suitable for commercial and residential construction according to EN 12209:2003, Usage Class 3, as well as for use in public buildings. greenteQ mortise locks RF fulfil the terms, dimensions, requirements, tests and identification for frame mortise locks with latches and/or locking bolts of DIN 18251-2.



greenteQ mortise locks RF are characterised by high saw-through resistance through the use of two hardened and loosely mounted steel pins in the latch as well as the closed construction of the lock chamber, solidly bolted to the face plate. In addition, greenteQ mortise locks RF are equipped with a high-quality machined face plate with a thickness of 3 mm.

With a bolt extension of 20 mm – single-throw, greenteQ mortise locks RF offer easy operation and a high level of protection. greenteQ mortise locks RF can be used on the left and right side, due to the reversible latch. The working height of the lock case is 15 mm. greenteQ mortise locks RF are preconfigured for profile cylinders and are certified in accordance with DIN 18252.

#### Technical data:

- Face plate material: Galvanised steel (high corrosion resistance)
- Bolt and latch material: Zink die-cast
- Lock case material: Sendzimir-galvanised sheet
- Follower material: Galvanised steel
- Latch: Rolling latch
- Classification key according to EN 12209:2003:  
Backset 25 - 55 mm | 3 | H | 4 | 0 | 0 | F | 6 | H | A | 0 | 0 |

Face plate	Backset	Follower	PU	VBH Article-No.
16 mm	25 mm	8 mm	1 pc.	396.443 / 6500
16 mm	35 mm	8 mm	1 pc.	396.444 / 6500
16 mm	40 mm	8 mm	1 pc.	397.329 / 6500
16 mm	45 mm	8 mm	1 pc.	396.445 / 6500
16 mm	55 mm	8 mm	1 pc.	396.446 / 6500
20 mm	55 mm	8 mm	1 pc.	396.447 / 6500
24 mm	25 mm	8 mm	1 pc.	397.755 / 6500
24 mm	35 mm	8 mm	1 pc.	397.756 / 6500

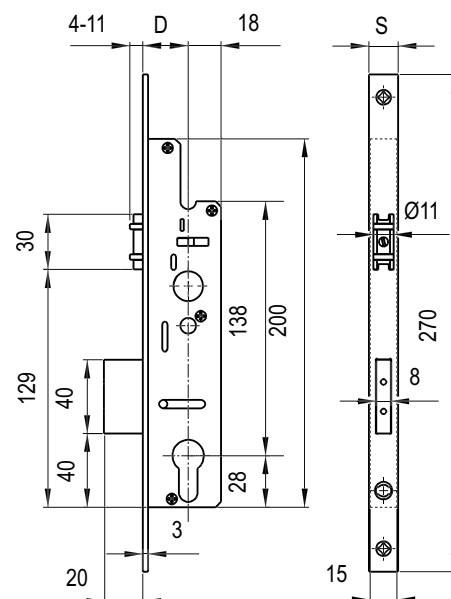

# DOOR HARDWARE

## Mortise locks

### greenteQ RR lock FS PZ

greenteQ mortise locks FS for frame doors are suitable for commercial and residential construction according to EN 12209:2003, Usage Class 3, as well as for use in public buildings. In addition, greenteQ mortise locks FS are certified according to CE fire protection certificate EN 1634-2.







greenteQ mortise locks FS fulfill the terms, dimensions, requirements, tests and identification for mortise locks with latches and/or locking bolts of DIN 18251-2. greenteQ mortise locks FS are characterised by high saw-through resistance through the use of two hardened and loosely mounted steel pins in the latch as well as the closed construction of the lock case, solidly bolted to the face plate. In addition, greenteQ mortise locks FS are equipped with a high-quality machined face plate with a thickness of 3 mm.

With a bolt extension of 20 mm – single-throw, greenteQ mortise locks RR offer easy operation and a high level of protection. greenteQ mortise locks FS can be used on the left and right side, due to the reversible latch. The working height of the lock case is 15 mm. greenteQ mortise locks FS are preconfigured for profile cylinders and are certified in accordance with DIN 18252.

#### Technical data:

- Face plate material: Galvanised steel (high corrosion resistance)
- Bolt and latch material: Zink die-cast
- Lock case material: Sendzimir-galvanised sheet
- Follower material: Galvanised steel
- Latch: Right/left reversible
- Classification key according to EN 12209:2003  
Backset 25 mm | 3 | M | 4 | 1 | 0 | F | 4 | H | A | 2 | 0 |  
Backset 35 - 55 mm | 3 | M | 4 | 1 | 0 | F | 6 | H | A | 2 | 0 |

Face plate	Backset	Follower	PU	VBH Article-No.
24 mm	25 mm	9 mm	1 pc.	397.753 / 6500 
24 mm	35 mm	9 mm	1 pc.	397.754 / 6500 
24 mm	40 mm	9 mm	1 pc.	399.126 / 6500 
24 mm	45 mm	9 mm	1 pc.	399.127 / 6500 

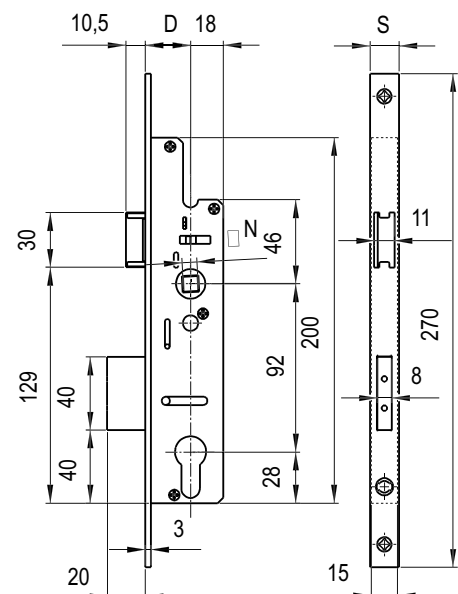

# DOOR HARDWARE

## Mortise locks

### greenteQ Middle locking plate

Description	Direction	PU	VBH Article-No.
Type 1	left	1 pc.	397.220 / 4011
Type 1	right	1 pc.	397.220 / 4012
Type 2	left	1 pc.	397.316 / 4011
Type 2	right	1 pc.	397.316 / 4012
Type 3	left	1 pc.	397.317 / 4011
Type 3	right	1 pc.	397.317 / 4012
Type 4	left	1 pc.	397.318 / 4011
Type 4	right	1 pc.	397.318 / 4012
Type 5	left	1 pc.	397.319 / 4011
Type 5	right	1 pc.	397.319 / 4012
Type 6	left	1 pc.	397.320 / 4011
Type 6	right	1 pc.	397.320 / 4012
Type 7	left	1 pc.	397.321 / 4011
Type 7	right	1 pc.	397.321 / 4012

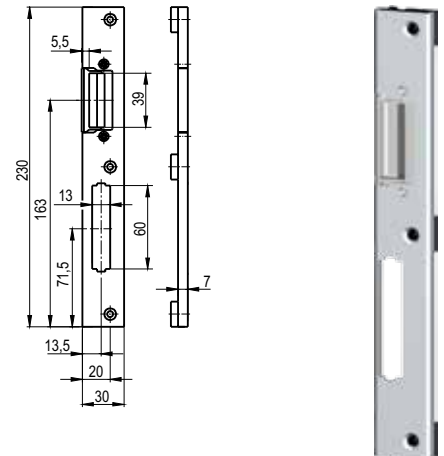

PROFILE SYSTEM	Typ 1 vz		Typ 2 vz		Typ 3 vz		Typ 4 vz		Typ 5 vz		Typ 6 vz		Typ 7 vz	
	rs	ls	rs	ls	rs	ls	rs	ls	rs	ls	rs	ls	rs	ls
Aluplast Ideal 2000 AD			X	X										
Aluplast Ideal 2000 AD (Side entry door)			X	X										
Aluplast Ideal 4000 AD	X	X												
Aluplast Ideal 4000 AD (Side entry door)	X	X												
Gealan S7000 IQ (Side entry door) 5K					X	X								
Gealan S8000 IQ					X	X								
Gealan S8000 IQ (Side entry door)					X	X								
KBE AD 70mm System (Side entry door)					X	X								
KBE MD 70 (Side entry door)					X	X								
Kömmerling 88 plus (MD)													X	X
Kömmerling 88 plus (MD) (Side entry door)													X	X
Kömmerling EuroFutur Classic													X	X
Kömmerling EuroFutur Classic (Side entry door)													X	X
LB-Profile PAD			X	X										
Rehau Geneo							X	X						
Rehau Brillant-Design (Side entry door)							X	X						
Rehau Thermo Design (S730)							X	X						
Salamander Design 2D (Side entry door)									X	X				
Schüco Corona AS 60	X	X												
Schüco Corona CT 70 AS											X	X		
Schüco Corona CT 70 AS (Side entry door)											X	X		
Schüco Corona SI 82 (Side entry door)											X	X		
Veka Alphaline 90 MD (Side entry door)			X	X										
Veka Softline AD 70 (Side entry door)			X	X										
Veka Softline MD (Side entry door)			X	X										
Veka Topline AD (Side door entry) (Frame: 104mm)			X	X										

# DOOR HARDWARE

## Multi-point locks greenteQ

### greenteQ Multi-point lock DB PZ 92mm P4 vz



greenteQ offers a wide range of high-quality, lever-handle-operated multi-point locks with additional latches for front doors and side entrances made of plastic or aluminium up to 60 kg. A high level of basic security is ensured, not just by the stable main lock with a latch and a locking bolt featuring saw-through resistance, but also by means of steel pin reinforcement. The latch and locking bolt are made from die-cast zinc; the latch has been galvanised and the locking bolt nickel-plated. The additional latches with 4 mushroom rollers or 2 round bolts ensure additional security, allow the door to be tightened powerfully and prevent it from being pried open. The dimensions and security requirements have been tested in accordance with DIN 18251-3. The greenteQ multi-point locks have been preconfigured for installing all profile cylinders certified in accordance with DIN 18252 or EN 1303. The main and additional locking parts are handle operated and ensure a user-friendly mechanism with a built-in oil duct for lubrication. You will also find a profile-based list of all main and ancillary strike plates below.

**You get a 5 YEAR WARRANTY on the function.**

#### Technical data:

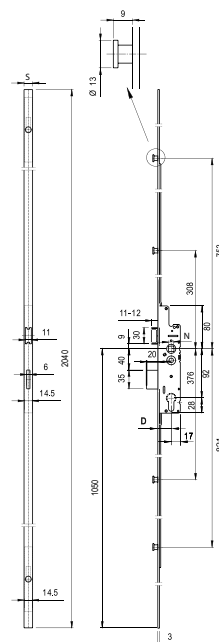
- Face plate material: Galvanised steel (high corrosion resistance)
- Lockcase material: Galvanised steel (high corrosion resistance)
- Mushroom roller material: Galvanised steel (high corrosion resistance)
- Round bolt material: Galvanised steel (high corrosion resistance)
- Operation: lever handle operated
- Operation locking: 4 mushroom rollers
- Bolt extension: 20 mm (2-tourig)
- Latch: DIN RS and LS usable
- Bolt: saw-through resistance
- Adjustable mushroom rollers: +/- 2 mm



Face plate	Backset	Follower	VBH Article-No.
16 mm	35 mm	8 mm	396.415 / 6500 
16 mm	45 mm	8 mm	396.416 / 6500 
20 x 3 mm	65 mm	10 mm	396.417 / 6500 



# DOOR HARDWARE

## Multi-point locks greenteQ

### greenteQ Additional striking plate P4

greenteQ Additional striking plate for mushroom roller.

Description	PU	VBH Article-No.	
Type 1	1 pc.	398.120 / 4010	
Type 2	1 pc.	398.121 / 4010	
Type 3	1 pc.	398.122 / 4010	
Type 4	1 pc.	398.123 / 4010	
Type 5	1 pc.	398.124 / 4010	
Type 6	1 pc.	398.125 / 4010	
Type 7	1 pc.	398.126 / 4010	

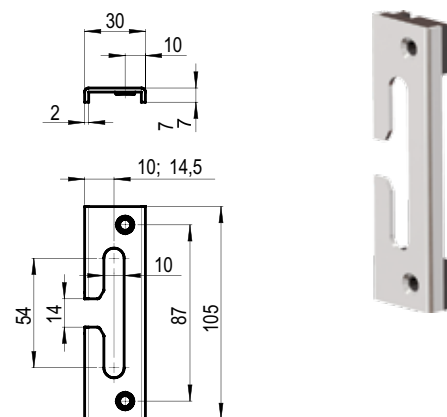

PROFILE SYSTEM	Typ 1 vz	Typ 2 vz	Typ 3 vz	Typ 4 vz	Typ 5 vz	Typ 6 vz	Typ 7 vz
Aluplast Ideal 2000 AD		X					
Aluplast Ideal 2000 AD (Side entry door)		X					
Aluplast Ideal 4000 AD	X						
Aluplast Ideal 4000 AD (Side entry door)	X						
Gealan S7000 IQ (Side entry door) 5K			X				
Gealan S8000 IQ			X				
Gealan S8000 IQ (Side entry door)			X				
KBE AD 70mm System (Side entry door)			X				
KBE MD 70 (Side entry door)							
Kömmerling 88 plus (MD)							X
Kömmerling 88 plus (MD) (Side entry door)							X
Kömmerling EuroFutur Classic							X
Kömmerling EuroFutur Classic (Side entry door)							
LB-Profile PAD		X					
Rehau Geneo				X			
Rehau Brillant-Design (Side entry door)				X			
Rehau Thermo Design (S730)				X			
Salamander Design 2D (Side entry door)					X		
Schüco Corona AS 60	X						
Schüco Corona CT 70 AS							X
Schüco Corona CT 70 AS (Side entry door)						X	
Schüco Corona SI 82 (Side entry door)						X	
Veka Alphasline 90 MD (Side entry door)							
Veka Softline AD 70 (Side entry door)		X					
Veka Softline MD (Side entry door)		X					
Veka Topline AD (Side door entry) (Frame: 104mm)		X					

# DOOR HARDWARE

## Multi-point locks greenteQ

### greenteQ Multi-point lock DB PZ 92mm B2 vz



greenteQ offers a wide range of high-quality, lever-handle-operated multi-point locks with additional latches for front doors and side entrances made of plastic or aluminium up to 60 kg. A high level of basic security is ensured, not just by the stable main lock with a latch and a locking bolt featuring saw-through resistance, but also by means of steel pin reinforcement. The latch and locking bolt are made from die-cast zinc; the latch has been galvanised and the locking bolt nickel-plated. The additional latches with 4 mushroom rollers or 2 round bolts ensure additional security, allow the door to be tightened powerfully and prevent it from being pried open. The dimensions and security requirements have been tested in accordance with DIN 18251-3. The greenteQ multi-point locks have been preconfigured for installing all profile cylinders certified in accordance with DIN 18252 or EN 1303. The main and additional locking parts are handle operated and ensure a user-friendly mechanism with a built-in oil duct for lubrication. You will also find a profile-based list of all main and ancillary strike plates below.

**You get a 5 YEAR WARRANTY on the function.**

#### Technical data:

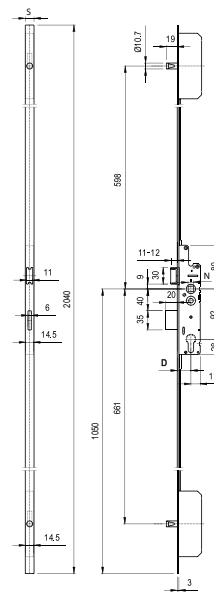
- Face plate material: Galvanised steel (high corrosion resistance)
- Lockcase material: Galvanised steel (high corrosion resistance)
- Mushroom roller material: Galvanised steel (high corrosion resistance)
- Round bolt material: Galvanised steel (high corrosion resistance)
- Operation: lever handle operated
- Operation locking: 2 round bolts
- Bolt extension: 20 mm (2-tourig)
- Latch: DIN RS and LS usable
- Bolt: saw-through resistance
- Adjustable mushroom rollers: +/- 2 mm



Face plate	Backset	Follower	VBH Article-No.
16 mm	35 mm	8 mm	396.418 / 6500 
16 mm	45 mm	8 mm	396.419 / 6500 
20 x 3 mm	65 mm	10 mm	396.420 / 6500 





# DOOR HARDWARE

## Multi-point locks greenteQ

### greenteQ Middle locking plate

Description	Direction	PU	VBH Article-No.
Type 1	left	1 pc.	397.220 / 4011
Type 1	right	1 pc.	397.220 / 4012
Type 2	left	1 pc.	397.316 / 4011
Type 2	right	1 pc.	397.316 / 4012
Type 3	left	1 pc.	397.317 / 4011
Type 3	right	1 pc.	397.317 / 4012
Type 4	left	1 pc.	397.318 / 4011
Type 4	right	1 pc.	397.318 / 4012
Type 5	left	1 pc.	397.319 / 4011
Type 5	right	1 pc.	397.319 / 4012
Type 6	left	1 pc.	397.320 / 4011
Type 6	right	1 pc.	397.320 / 4012
Type 7	left	1 pc.	397.321 / 4011
Type 7	right	1 pc.	397.321 / 4012

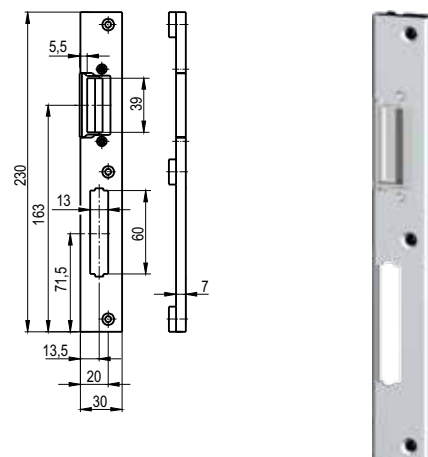

PROFILE SYSTEM	Typ 1 vz		Typ 2 vz		Typ 3 vz		Typ 4 vz		Typ 5 vz		Typ 6 vz		Typ 7 vz	
	rs	ls	rs	ls	rs	ls	rs	ls	rs	ls	rs	ls	rs	ls
Aluplast Ideal 2000 AD			X	X										
Aluplast Ideal 2000 AD (Side entry door)			X	X										
Aluplast Ideal 4000 AD	X	X												
Aluplast Ideal 4000 AD (Side entry door)	X	X												
Gealan S7000 IQ (Side entry door) 5K					X	X								
Gealan S8000 IQ					X	X								
Gealan S8000 IQ (Side entry door)					X	X								
KBE AD 70mm System (Side entry door)					X	X								
KBE MD 70 (Side entry door)					X	X								
Kömmerling 88 plus (MD)													X	X
Kömmerling 88 plus (MD) (Side entry door)													X	X
Kömmerling EuroFutur Classic													X	X
Kömmerling EuroFutur Classic (Side entry door)													X	X
LB-Profile PAD			X	X										
Rehau Geneo							X	X						
Rehau Brillant-Design (Side entry door)							X	X						
Rehau Thermo Design (S730)							X	X						
Salamander Design 2D (Side entry door)									X	X				
Schüco Corona AS 60	X	X												
Schüco Corona CT 70 AS												X	X	
Schüco Corona CT 70 AS (Side entry door)												X	X	
Schüco Corona SI 82 (Side entry door)												X	X	
Veka Alphaline 90 MD (Side entry door)			X	X										
Veka Softline AD 70 (Side entry door)			X	X										
Veka Softline MD (Side entry door)			X	X										
Veka Topline AD (Side door entry) (Frame: 104mm)			X	X										

# DOOR HARDWARE

## Profile cylinder keyed different

### greenteQ Profile double cylinder SX GF keyed different

greenteQ profile double cylinder SX; standard profil, 6 pin system; emergency function (bilateral opening); certification according to EN 1303 : 2005; drilling protection; core extraction protection; anti-picking; basic length 30/30 mm; deliverable extensions at one side or both sides each by 5 mm possible; supplied with 3 keys; brass matt nickel-plated; keyed different (every cylinder has individual locking).

#### Technical data:

- Material of profile cylinder: brass
- Surface: satin nickel-plated
- Pins: 6
- Emergency function: yes
- Certification acc. to: EN 1303:2005/AC:2008; FZG 2010\_01
- Closure: 8-way adjustable
- Keys: 3
- Fixing screw: 1 x M5 x 50 mm and 1 x M5 x 80 mm



Keyed alike	Length A	Length B	VBH Article-No.
keyed different	30	30	387.487 / 0011
keyed different	30	35	387.488 / 0011
keyed different	30	40	387.489 / 0011
keyed different	30	45	387.490 / 0011
keyed different	30	50	387.491 / 0011
keyed different	30	55	387.492 / 0011
keyed different	30	60	387.493 / 0011
keyed different	30	65	395.483 / 0011
keyed different	30	70	395.484 / 0011
keyed different	30	75	999.990 / 2007
keyed different	35	35	387.494 / 0011
keyed different	35	40	387.495 / 0011
keyed different	35	45	387.496 / 0011
keyed different	35	50	387.497 / 0011
keyed different	35	55	387.498 / 0011
keyed different	35	60	387.499 / 0011
keyed different	35	65	387.500 / 0011
keyed different	35	70	387.501 / 0011
keyed different	40	40	387.502 / 0011
keyed different	40	45	387.503 / 0011
keyed different	40	50	387.504 / 0011
keyed different	40	55	387.505 / 0011
keyed different	40	60	387.506 / 0011
keyed different	40	65	389.598 / 0011
keyed different	40	70	389.599 / 0011
keyed different	45	45	387.507 / 0011
keyed different	45	50	387.508 / 0011
keyed different	45	55	387.509 / 0011
keyed different	45	60	387.510 / 0011
keyed different	45	65	387.511 / 0011
keyed different	50	50	387.512 / 0011
keyed different	50	55	389.600 / 0011
keyed different	50	60	389.601 / 0011

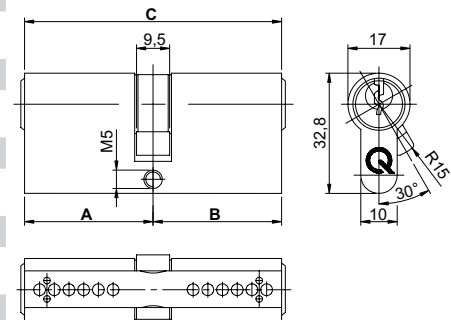

# DOOR HARDWARE

## Profile cylinder keyed different

### greenteQ Profile knob cylinder SX keyed different

greenteQ profile knob cylinder SX; standard profile; 6 pin system; certification according to EN 1303 : 2005; drilling protection; core extraction protection; anti-picking; basic length 30/30 mm; deliverable extensions at one side or both sides each by 5 mm possible; supplied with 3 keys; brass matt nickel-plated; keyed different (every cylinder has individual locking).

#### Technical data:

- Material of profile cylinder: brass
- Surface: satin nickel-plated
- Pins: 6
- Emergency function: yes
- Certification acc. to: EN 1303:2005/AC:2008; FZG 2010\_01
- Closure: 8-way adjustable
- Keys: 3
- Fixing screw: 1 x M5 x 50 mm and 1 x M5 x 80 mm



Keyed alike	Length A	Length B	VBH Article-No.
keyed different	30	30	389.611 / 0011
keyed different	30	35	389.612 / 0011
keyed different	30	40	389.613 / 0011
keyed different	30	45	389.614 / 0011
keyed different	35	30	389.615 / 0011
keyed different	35	35	389.616 / 0011
keyed different	35	40	389.617 / 0011
keyed different	35	45	389.618 / 0011
keyed different	35	50	389.619 / 0011
keyed different	35	55	389.620 / 0011
keyed different	40	30	389.621 / 0011
keyed different	40	35	389.622 / 0011
keyed different	40	40	389.623 / 0011
keyed different	40	45	389.624 / 0011
keyed different	40	50	389.625 / 0011
keyed different	40	55	389.626 / 0011
keyed different	45	30	389.633 / 0011
keyed different	45	35	389.634 / 0011
keyed different	45	40	389.635 / 0011
keyed different	45	45	389.636 / 0011
keyed different	45	50	389.637 / 0011
keyed different	50	35	389.638 / 0011
keyed different	50	40	389.639 / 0011
keyed different	50	45	389.640 / 0011
keyed different	50	50	389.641 / 0011
keyed different	55	35	389.642 / 0011
keyed different	55	40	389.643 / 0011
keyed different	60	40	389.644 / 0011
keyed different	60	45	396.524 / 0011
keyed different	65	40	389.645 / 0011

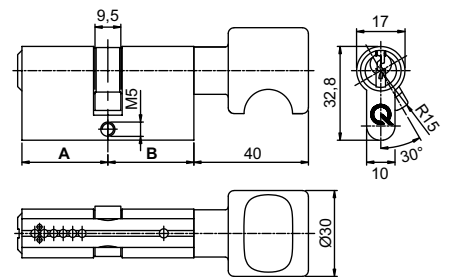

# DOOR HARDWARE

## Profile cylinder keyed different

### greenteQ Profile half cylinder SX 8-F keyed different

greenteQ profile half cylinder SX 8-F are made off brass matt nickel-plated and the standard cylinder has a 6 pin system. They are tested and certified according to EN 1303:2005/AC:2008, have an 8-fold adjustable cam and have a drilling protection, core extraction protection as well as anti-picking. The basic length of the greenteQ profile half cylinders SX 8-F is 30 mm; available extensions at one side by 5 mm are possible. The cylinders are delivered with 3 keys.

greenteQ profile half cylinders SX 8-F are keyed different (every cylinder has individual locking. The 3 keys delivered with the cylinder aren't useable for other cylinders) or keyed alike (all cylinders with the same locking could be opened or closed with one key). If needed key blank for keyed different cylinders or keys for keyed alike cylinders are available.

#### Instruction manual for the 8-fold adjustable cam:

New functionality of greenteQ profile half cylinder SX 8-F: The lock cam is at an angle of 45° 8-fold adjustable, so that the cylinder is usable in various installation situations (lockable window handles, key switch etc.).







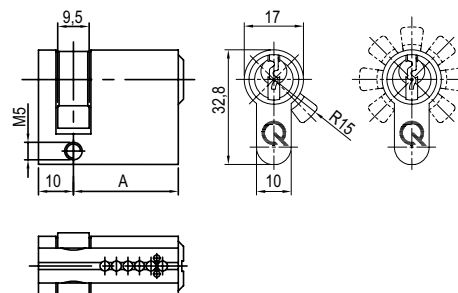

This is how it works:

Press the thrust bolt on the back of the cylinder with a pointed object (key, fixing screw etc.); turn the lock cam in the desired position; release the thrust bolt; the thrust bolt engages then automatically.

#### Technical data:

- Material of profile cylinder: brass
- Surface: satin nickel-plated
- Pins: 6
- Emergency function: yes
- Certification acc. to: EN 1303:2005/AC:2008; FZG 2010\_01
- Closure: 8-way adjustable
- Keys: 3
- Fixing screw: 1 x M5 x 50 mm and 1 x M5 x 80 mm



Keyed alike	Length A	VBH Article-No.
keyed different	30	392.794 / 0011 
keyed different	55	395.476 / 0011 
keyed different	60	395.477 / 0011 
keyed different	65	395.478 / 0011 
keyed different	70	395.479 / 0011 
keyed different	35	392.795 / 0011 
keyed different	40	392.796 / 0011 
keyed different	45	392.797 / 0011 
keyed different	50	392.798 / 0011 

### greenteQ Key blank

greenteQ key blank for greenteQ profile double cylinder SX, SX greenteQ profile half-cylinder 8-F, greenteQ Profile knob cylinder SX.

Description	PU	VBH Article-No.
Key blank	1 pc.	388.678 / 0000 
Key blank -milled-	1 pc.	391.872 / 0000 



# DOOR HARDWARE

## Profile cylinder keyed alike No. 1

### greenteQ Profile double cylinder SX GF Keyed alike No. 1

greenteQ profile double cylinder SX; standard profil, 6 pin system; emergency function (bilateral opening); certification according to EN 1303 : 2005; drilling protection; core extraction protection; anti-picking; basic length 30/30 mm; deliverable extensions at one side or both sides each by 5 mm possible; supplied with 3 keys; brass matt nickel-plated.

#### Technical data:

- Material of profile cylinder: brass
- Surface: satin nickel-plated
- Pins: 6
- Emergency function: yes
- Certification acc. to: EN 1303:2005/AC:2008; FZG 2010\_01
- Closure: 8-way adjustable
- Keys: 3
- Fixing screw: 1 x M5 x 50 mm and 1 x M5 x 80 mm



Keyed alike	Length A	Length B	VBH Article-No.
keyed alike No. 1	30	30	387.487 / 0001
keyed alike No. 1	30	35	387.488 / 0001
keyed alike No. 1	30	40	387.489 / 0001
keyed alike No. 1	30	45	387.490 / 0001
keyed alike No. 1	30	50	387.491 / 0001
keyed alike No. 1	30	55	387.492 / 0001
keyed alike No. 1	30	60	387.493 / 0001
keyed alike No. 1	30	65	395.483 / 0001
keyed alike No. 1	30	70	395.484 / 0001
keyed alike No. 1	30	75	999.990 / 2024
keyed alike No. 1	35	35	387.494 / 0001
keyed alike No. 1	35	40	387.495 / 0001
keyed alike No. 1	35	45	387.496 / 0001
keyed alike No. 1	35	50	387.497 / 0001
keyed alike No. 1	35	55	387.498 / 0001
keyed alike No. 1	35	60	387.499 / 0001
keyed alike No. 1	35	65	387.500 / 0001
keyed alike No. 1	35	70	387.501 / 0001
keyed alike No. 1	40	40	387.502 / 0001
keyed alike No. 1	40	45	387.503 / 0001
keyed alike No. 1	40	50	387.504 / 0001
keyed alike No. 1	40	55	387.505 / 0001
keyed alike No. 1	40	60	387.506 / 0001
keyed alike No. 1	40	65	389.598 / 0001
keyed alike No. 1	40	70	389.599 / 0001
keyed alike No. 1	45	45	387.507 / 0001
keyed alike No. 1	45	50	387.508 / 0001
keyed alike No. 1	45	55	387.509 / 0001
keyed alike No. 1	45	60	387.510 / 0001
keyed alike No. 1	45	65	387.511 / 0001
keyed alike No. 1	50	50	387.512 / 0001
keyed alike No. 1	50	55	389.600 / 0001
keyed alike No. 1	50	60	389.601 / 0001

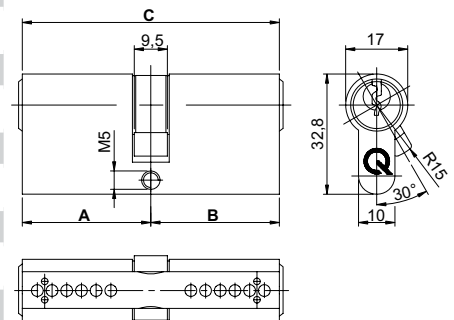

# DOOR HARDWARE

## Profile cylinder keyed alike No. 1

### greenteQ Profile knob cylinder SX keyed alike No. 1

greenteQ profile knob cylinder SX; standard profile; 6 pin system; certification according to EN 1303 : 2005; drilling protection; core extraction protection; anti-picking; basic length 30/30 mm; deliverable extensions at one side or both sides each by 5 mm possible; supplied with 3 keys; brass matt nickel-plated.

#### Technical data:

- Material of profile cylinder: brass
- Surface: satin nickel-plated
- Pins: 6
- Emergency function: yes
- Certification acc. to: EN 1303:2005/AC:2008; FZG 2010\_01
- Closure: 8-way adjustable
- Keys: 3
- Fixing screw: 1 x M5 x 50 mm and 1 x M5 x 80 mm



Keyed alike	Length A	Length B	VBH Article-No.
keyed alike No. 1	30	30	389.611 / 0001
keyed alike No. 1	30	35	389.612 / 0001
keyed alike No. 1	30	40	389.613 / 0001
keyed alike No. 1	30	45	389.614 / 0001
keyed alike No. 1	35	30	389.615 / 0001
keyed alike No. 1	35	35	389.616 / 0001
keyed alike No. 1	35	40	389.617 / 0001
keyed alike No. 1	35	45	389.618 / 0001
keyed alike No. 1	35	50	389.619 / 0001
keyed alike No. 1	35	55	389.620 / 0001
keyed alike No. 1	40	30	389.621 / 0001
keyed alike No. 1	40	35	389.622 / 0001
keyed alike No. 1	40	40	389.623 / 0001
keyed alike No. 1	40	45	389.624 / 0001
keyed alike No. 1	40	50	389.625 / 0001
keyed alike No. 1	40	55	389.626 / 0001
keyed alike No. 1	45	30	389.633 / 0001
keyed alike No. 1	45	35	389.634 / 0001
keyed alike No. 1	45	40	389.635 / 0001
keyed alike No. 1	45	45	389.636 / 0001
keyed alike No. 1	45	50	389.637 / 0001
keyed alike No. 1	50	35	389.638 / 0001
keyed alike No. 1	50	40	389.639 / 0001
keyed alike No. 1	50	45	389.640 / 0001
keyed alike No. 1	50	50	389.641 / 0001
keyed alike No. 1	55	35	389.642 / 0001
keyed alike No. 1	55	40	389.643 / 0001
keyed alike No. 1	60	40	389.644 / 0001
keyed alike No. 1	60	45	396.524 / 0001
keyed alike No. 1	65	40	389.645 / 0001

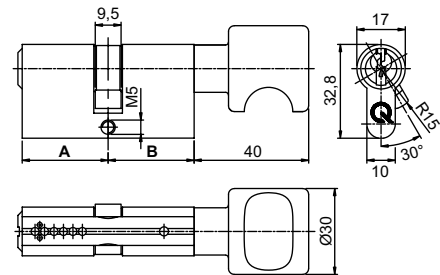

# DOOR HARDWARE

## Profile cylinder keyed alike No. 1

### greenteQ Profile half cylinder SX 8-F keyed alike No. 1

greenteQ profile half cylinder SX 8-F are made off brass matt nickel-plated and the standard cylinder has a 6 pin system. They are tested and certified according to EN 1303:2005/AC:2008, have an 8-fold adjustable cam and have a drilling protection, core extraction protection as well as anti-picking. The basic length of the greenteQ profile half cylinders SX 8-F is 30 mm; available extensions at one side by 5 mm are possible. The cylinders are delivered with 3 keys.

#### Instruction manual for the 8-fold adjustable cam:

New functionality of greenteQ profile half cylinder SX 8-F: The lock cam is at an angle of 45° 8-fold adjustable, so that the cylinder is usable in various installation situations (lockable window handles, key switch etc.).







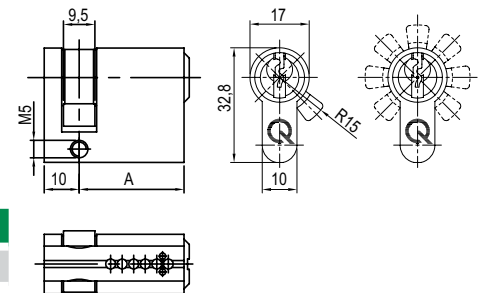

This is how it works:

Press the thrust bolt on the back of the cylinder with a pointed object (key, fixing screw etc.); turn the lock cam in the desired position; release the thrust bolt; the thrust bolt engages then automatically.

#### Technical data:

- Material of profile cylinder: brass
- Surface: satin nickel-plated
- Pins: 6
- Emergency function: yes
- Certification acc. to: EN 1303:2005/AC:2008; FZG 2010\_01
- Closure: 8-way adjustable
- Keys: 3
- Fixing screw: 1 x M5 x 50 mm and 1 x M5 x 80 mm



Keyed alike	Length A	VBH Article-No.
keyed alike No. 1	30	392.794 / 0001 
keyed alike No. 1	35	392.795 / 0001 
keyed alike No. 1	40	392.796 / 0001 
keyed alike No. 1	45	392.797 / 0001 
keyed alike No. 1	50	392.798 / 0001 
keyed alike No. 1	55	395.476 / 0001 
keyed alike No. 1	60	395.477 / 0001 
keyed alike No. 1	65	395.478 / 0001 
keyed alike No. 1	70	395.479 / 0001 

### greenteQ Additional change key keyed alike No. 1

greenteQ additional change key for greenteQ profile double cylinder SX, SX greenteQ profile half-cylinder 8-F, greenteQ Profile knob cylinder SX.

Keyed alike	PU	VBH Article-No.
keyed alike No. 1	1 pc.	389.646 / 0001 



# DOOR HARDWARE

## Profile cylinder keyed alike No. 2

### greenteQ Profile double cylinder SX GF Keyed alike No. 2

greenteQ profile double cylinder SX; standard profil, 6 pin system; emergency function (bilateral opening); certification according to EN 1303 : 2005; drilling protection; core extraction protection; anti-picking; basic length 30/30 mm; deliverable extensions at one side or both sides each by 5 mm possible; supplied with 3 keys; brass matt nickel-plated.

#### Technical data:

- Material of profile cylinder: brass
- Surface: satin nickel-plated
- Pins: 6
- Emergency function: yes
- Certification acc. to: EN 1303:2005/AC:2008; FZG 2010\_01
- Closure: 8-way adjustable
- Keys: 3
- Fixing screw: 1 x M5 x 50 mm and 1 x M5 x 80 mm



Keyed alike	Length A	Length B	VBH Article-No.
keyed alike No. 2	30	30	387.487 / 0002
keyed alike No. 2	30	35	387.488 / 0002
keyed alike No. 2	30	40	387.489 / 0002
keyed alike No. 2	30	45	387.490 / 0002
keyed alike No. 2	30	50	387.491 / 0002
keyed alike No. 2	30	55	387.492 / 0002
keyed alike No. 2	30	60	387.493 / 0002
keyed alike No. 2	30	65	395.483 / 0002
keyed alike No. 2	30	70	395.484 / 0002
keyed alike No. 2	30	75	999.990 / 2025
keyed alike No. 2	35	35	387.494 / 0002
keyed alike No. 2	35	40	387.495 / 0002
keyed alike No. 2	35	45	387.496 / 0002
keyed alike No. 2	35	50	387.497 / 0002
keyed alike No. 2	35	55	387.498 / 0002
keyed alike No. 2	35	60	387.499 / 0002
keyed alike No. 2	35	65	387.500 / 0002
keyed alike No. 2	35	70	387.501 / 0002
keyed alike No. 2	40	40	387.502 / 0002
keyed alike No. 2	40	45	387.503 / 0002
keyed alike No. 2	40	50	387.504 / 0002
keyed alike No. 2	40	55	387.505 / 0002
keyed alike No. 2	40	60	387.506 / 0002
keyed alike No. 2	40	65	389.598 / 0002
keyed alike No. 2	40	70	389.599 / 0002
keyed alike No. 2	45	45	387.507 / 0002
keyed alike No. 2	45	50	387.508 / 0002
keyed alike No. 2	45	55	387.509 / 0002
keyed alike No. 2	45	60	387.510 / 0002
keyed alike No. 2	45	65	387.511 / 0002
keyed alike No. 2	50	50	387.512 / 0002
keyed alike No. 2	50	55	389.600 / 0002
keyed alike No. 2	50	60	389.601 / 0002

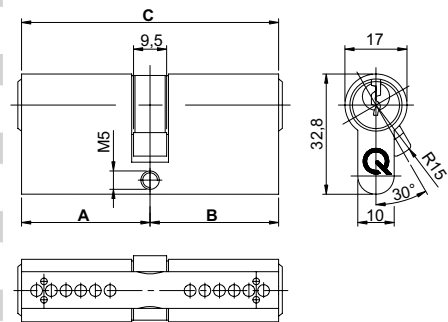



# DOOR HARDWARE

## Profile cylinder keyed alike No. 2

### greenteQ Profile knob cylinder SX keyed alike No. 2

greenteQ profile knob cylinder SX; standard profile; 6 pin system; certification according to EN 1303 : 2005; drilling protection; core extraction protection; anti-picking; basic length 30/30 mm; deliverable extensions at one side or both sides each by 5 mm possible; supplied with 3 keys; brass matt nickel-plated.

#### Technical data:

- Material of profile cylinder: brass
- Surface: satin nickel-plated
- Pins: 6
- Emergency function: yes
- Certification acc. to: EN 1303:2005/AC:2008; FZG 2010\_01
- Closure: 8-way adjustable
- Keys: 3
- Fixing screw: 1 x M5 x 50 mm and 1 x M5 x 80 mm



Keyed alike	Length A	Length B	VBH Article-No.
keyed alike No. 2	30	30	389.611 / 0002
keyed alike No. 2	30	35	389.612 / 0002
keyed alike No. 2	30	40	389.613 / 0002
keyed alike No. 2	30	45	389.614 / 0002
keyed alike No. 2	35	30	389.615 / 0002
keyed alike No. 2	35	35	389.616 / 0002
keyed alike No. 2	35	40	389.617 / 0002
keyed alike No. 2	35	45	389.618 / 0002
keyed alike No. 2	35	50	389.619 / 0002
keyed alike No. 2	35	55	389.620 / 0002
keyed alike No. 2	40	30	389.621 / 0002
keyed alike No. 2	40	35	389.622 / 0002
keyed alike No. 2	40	40	389.623 / 0002
keyed alike No. 2	40	45	389.624 / 0002
keyed alike No. 2	40	50	389.625 / 0002
keyed alike No. 2	40	55	389.626 / 0002
keyed alike No. 2	45	30	389.633 / 0002
keyed alike No. 2	45	35	389.634 / 0002
keyed alike No. 2	45	40	389.635 / 0002
keyed alike No. 2	45	45	389.636 / 0002
keyed alike No. 2	45	50	389.637 / 0002
keyed alike No. 2	50	35	389.638 / 0002
keyed alike No. 2	50	40	389.639 / 0002
keyed alike No. 2	50	45	389.640 / 0002
keyed alike No. 2	50	50	389.641 / 0002
keyed alike No. 2	55	35	389.642 / 0002
keyed alike No. 2	55	40	389.643 / 0002
keyed alike No. 2	60	40	389.644 / 0002
keyed alike No. 2	60	45	396.524 / 0002
keyed alike No. 2	65	40	389.645 / 0002

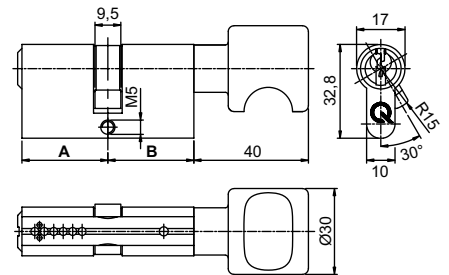

# DOOR HARDWARE

## Profile cylinder keyed alike No. 2

### greenteQ Profile half cylinder SX 8-F keyed alike No. 2

greenteQ profile half cylinder SX 8-F are made off brass matt nickel-plated and the standard cylinder has a 6 pin system. They are tested and certified according to EN 1303:2005/AC:2008, have an 8-fold adjustable cam and have a drilling protection, core extraction protection as well as anti-picking. The basic length of the greenteQ profile half cylinders SX 8-F is 30 mm; available extensions at one side by 5 mm are possible. The cylinders are delivered with 3 keys.

#### Instruction manual for the 8-fold adjustable cam:

New functionality of greenteQ profile half cylinder SX 8-F: The lock cam is at an angle of 45° 8-fold adjustable, so that the cylinder is usable in various installation situations (lockable window handles, key switch etc.).

This is how it works:

Press the thrust bolt on the back of the cylinder with a pointed object (key, fixing screw etc.); turn the lock cam in the desired position; release the thrust bolt; the thrust bolt engages then automatically.

#### Technical data:

- Material of profile cylinder: brass
- Surface: satin nickel-plated
- Pins: 6
- Emergency function: yes
- Certification acc. to: EN 1303:2005/AC:2008; FZG 2010\_01
- Closure: 8-way adjustable
- Keys: 3
- Fixing screw: 1 x M5 x 50 mm and 1 x M5 x 80 mm

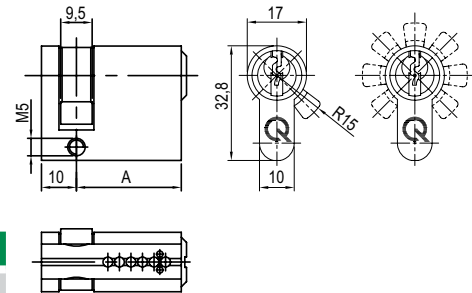

Keyed alike	Length A	VBH Article-No.
keyed alike No. 2	30	392.794 / 0002
keyed alike No. 2	35	392.795 / 0002
keyed alike No. 2	40	392.796 / 0002
keyed alike No. 2	45	392.797 / 0002
keyed alike No. 2	50	392.798 / 0002
keyed alike No. 2	55	395.476 / 0002
keyed alike No. 2	60	395.477 / 0002
keyed alike No. 2	65	395.478 / 0002
keyed alike No. 2	70	395.479 / 0002

### greenteQ Additional change key keyed alike No. 2

greenteQ additional change key for greenteQ profile double cylinder SX, SX greenteQ profile half-cylinder 8-F, greenteQ Profile knob cylinder SX.

Keyed alike	PU	VBH Article-No.
keyed alike No. 2	1 pc.	389.646 / 0002



# DOOR HARDWARE

## Profile cylinder keyed alike No. 3

### greenteQ Profile double cylinder SX GF Keyed alike No. 3

greenteQ profile double cylinder SX; standard profil, 6 pin system; emergency function (bilateral opening); certification according to EN 1303 : 2005; drilling protection; core extraction protection; anti-picking; basic length 30/30 mm; deliverable extensions at one side or both sides each by 5 mm possible; supplied with 3 keys; brass matt nickel-plated.

#### Technical data:

- Material of profile cylinder: brass
- Surface: satin nickel-plated
- Pins: 6
- Emergency function: yes
- Certification acc. to: EN 1303:2005/AC:2008; FZG 2010\_01
- Closure: 8-way adjustable
- Keys: 3
- Fixing screw: 1 x M5 x 50 mm and 1 x M5 x 80 mm



Keyed alike	Length A	Length B	VBH Article-No.
keyed alike No. 3	30	30	387.487 / 0003
keyed alike No. 3	30	35	387.488 / 0003
keyed alike No. 3	30	40	387.489 / 0003
keyed alike No. 3	30	45	387.490 / 0003
keyed alike No. 3	30	50	387.491 / 0003
keyed alike No. 3	30	55	387.492 / 0003
keyed alike No. 3	30	60	387.493 / 0003
keyed alike No. 3	30	65	395.483 / 0003
keyed alike No. 3	30	70	395.484 / 0003
keyed alike No. 3	30	75	999.990 / 2026
keyed alike No. 3	35	35	387.494 / 0003
keyed alike No. 3	35	40	387.495 / 0003
keyed alike No. 3	35	45	387.496 / 0003
keyed alike No. 3	35	50	387.497 / 0003
keyed alike No. 3	35	55	387.498 / 0003
keyed alike No. 3	35	60	387.499 / 0003
keyed alike No. 3	35	65	387.500 / 0003
keyed alike No. 3	35	70	387.501 / 0003
keyed alike No. 3	40	40	387.502 / 0003
keyed alike No. 3	40	45	387.503 / 0003
keyed alike No. 3	40	50	387.504 / 0003
keyed alike No. 3	40	55	387.505 / 0003
keyed alike No. 3	40	60	387.506 / 0003
keyed alike No. 3	40	65	389.598 / 0003
keyed alike No. 3	40	70	389.599 / 0003
keyed alike No. 3	45	45	387.507 / 0003
keyed alike No. 3	45	50	387.508 / 0003
keyed alike No. 3	45	55	387.509 / 0003
keyed alike No. 3	45	60	387.510 / 0003
keyed alike No. 3	45	65	387.511 / 0003
keyed alike No. 3	50	50	387.512 / 0003
keyed alike No. 3	50	55	389.600 / 0003
keyed alike No. 3	50	60	389.601 / 0003

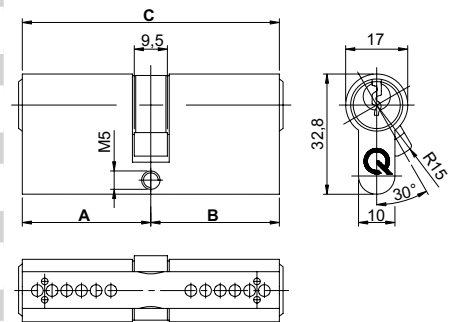

# DOOR HARDWARE

## Profile cylinder keyed alike No. 3

### greenteQ Profile knob cylinder SX keyed alike No. 3

greenteQ profile knob cylinder SX; standard profile; 6 pin system; certification according to EN 1303 : 2005; drilling protection; core extraction protection; anti-picking; basic length 30/30 mm; deliverable extensions at one side or both sides each by 5 mm possible; supplied with 3 keys; brass matt nickel-plated.

#### Technical data:

- Material of profile cylinder: brass
- Surface: satin nickel-plated
- Pins: 6
- Emergency function: yes
- Certification acc. to: EN 1303:2005/AC:2008; FZG 2010\_01
- Closure: 8-way adjustable
- Keys: 3
- Fixing screw: 1 x M5 x 50 mm and 1 x M5 x 80 mm



Keyed alike	Length A	Length B	VBH Article-No.
keyed alike No. 3	30	30	389.611 / 0003
keyed alike No. 3	30	35	389.612 / 0003
keyed alike No. 3	30	40	389.613 / 0003
keyed alike No. 3	30	45	389.614 / 0003
keyed alike No. 3	35	30	389.615 / 0003
keyed alike No. 3	35	35	389.616 / 0003
keyed alike No. 3	35	40	389.617 / 0003
keyed alike No. 3	35	45	389.618 / 0003
keyed alike No. 3	35	50	389.619 / 0003
keyed alike No. 3	35	55	389.620 / 0003
keyed alike No. 3	40	30	389.621 / 0003
keyed alike No. 3	40	35	389.622 / 0003
keyed alike No. 3	40	40	389.623 / 0003
keyed alike No. 3	40	45	389.624 / 0003
keyed alike No. 3	40	50	389.625 / 0003
keyed alike No. 3	40	55	389.626 / 0003
keyed alike No. 3	45	30	389.633 / 0003
keyed alike No. 3	45	35	389.634 / 0003
keyed alike No. 3	45	40	389.635 / 0003
keyed alike No. 3	45	45	389.636 / 0003
keyed alike No. 3	45	50	389.637 / 0003
keyed alike No. 3	50	35	389.638 / 0003
keyed alike No. 3	50	40	389.639 / 0003
keyed alike No. 3	50	45	389.640 / 0003
keyed alike No. 3	50	50	389.641 / 0003
keyed alike No. 3	55	35	389.642 / 0003
keyed alike No. 3	55	40	389.643 / 0003
keyed alike No. 3	60	40	389.644 / 0003
keyed alike No. 3	60	45	396.524 / 0003
keyed alike No. 3	65	40	389.645 / 0003

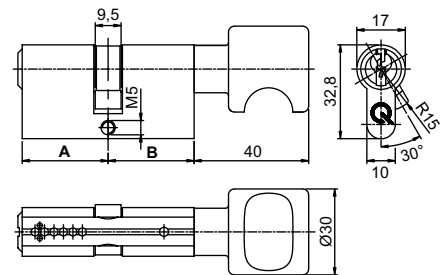

# DOOR HARDWARE

## Profile cylinder keyed alike No. 3

### greenteQ Profile half cylinder SX 8-F keyed alike No. 3

greenteQ profile half cylinder SX 8-F are made off brass matt nickel-plated and the standard cylinder has a 6 pin system. They are tested and certified according to EN 1303:2005/AC:2008, have an 8-fold adjustable cam and have a drilling protection, core extraction protection as well as anti-picking. The basic length of the greenteQ profile half cylinders SX 8-F is 30 mm; available extensions at one side by 5 mm are possible. The cylinders are delivered with 3 keys.

#### Instruction manual for the 8-fold adjustable cam:

New functionality of greenteQ profile half cylinder SX 8-F: The lock cam is at an angle of 45° 8-fold adjustable, so that the cylinder is usable in various installation situations (lockable window handles, key switch etc.).

This is how it works:

Press the thrust bolt on the back of the cylinder with a pointed object (key, fixing screw etc.); turn the lock cam in the desired position; release the thrust bolt; the thrust bolt engages then automatically.

#### Technical data:

- Material of profile cylinder: brass
- Surface: satin nickel-plated
- Pins: 6
- Emergency function: yes
- Certification acc. to: EN 1303:2005/AC:2008; FZG 2010\_01
- Closure: 8-way adjustable
- Keys: 3
- Fixing screw: 1 x M5 x 50 mm and 1 x M5 x 80 mm

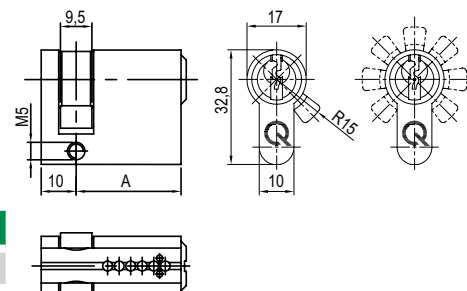

Keyed alike	Length A	VBH Article-No.	
keyed alike No. 3	30	392.794 / 0003	
keyed alike No. 3	35	392.795 / 0003	
keyed alike No. 3	40	392.796 / 0003	
keyed alike No. 3	45	392.797 / 0003	
keyed alike No. 3	50	392.798 / 0003	
keyed alike No. 3	55	395.476 / 0003	
keyed alike No. 3	60	395.477 / 0003	
keyed alike No. 3	65	395.478 / 0003	
keyed alike No. 3	70	395.479 / 0003	

### greenteQ Additional change key keyed alike No. 3

greenteQ additional change key for greenteQ profile double cylinder SX, SX greenteQ profile half-cylinder 8-F, greenteQ Profile knob cylinder SX.

Keyed alike	PU	VBH Article-No.	
keyed alike No. 3	1 pc.	389.646 / 0003	



# DOOR HARDWARE

## Profile cylinder keyed alike No. 4

### greenteQ Profile double cylinder SX GF Keyed alike No. 4

greenteQ profile double cylinder SX; standard profil, 6 pin system; emergency function (bilateral opening); certification according to EN 1303 : 2005; drilling protection; core extraction protection; anti-picking; basic length 30/30 mm; deliverable extensions at one side or both sides each by 5 mm possible; supplied with 3 keys; brass matt nickel-plated.

#### Technical data:

- Material of profile cylinder: brass
- Surface: satin nickel-plated
- Pins: 6
- Emergency function: yes
- Certification acc. to: EN 1303:2005/AC:2008; FZG 2010\_01
- Closure: 8-way adjustable
- Keys: 3
- Fixing screw: 1 x M5 x 50 mm and 1 x M5 x 80 mm



Keyed alike	Length A	Length B	VBH Article-No.
keyed alike No. 4	30	30	387.487 / 0004
keyed alike No. 4	30	35	387.488 / 0004
keyed alike No. 4	30	40	387.489 / 0004
keyed alike No. 4	30	45	387.490 / 0004
keyed alike No. 4	30	50	387.491 / 0004
keyed alike No. 4	30	55	387.492 / 0004
keyed alike No. 4	30	60	387.493 / 0004
keyed alike No. 4	30	65	395.483 / 0004
keyed alike No. 4	30	70	395.484 / 0004
keyed alike No. 4	30	75	999.990 / 2027
keyed alike No. 4	35	35	387.494 / 0004
keyed alike No. 4	35	40	387.495 / 0004
keyed alike No. 4	35	45	387.496 / 0004
keyed alike No. 4	35	50	387.497 / 0004
keyed alike No. 4	35	55	387.498 / 0004
keyed alike No. 4	35	60	387.499 / 0004
keyed alike No. 4	35	65	387.500 / 0004
keyed alike No. 4	35	70	387.501 / 0004
keyed alike No. 4	40	40	387.502 / 0004
keyed alike No. 4	40	45	387.503 / 0004
keyed alike No. 4	40	50	387.504 / 0004
keyed alike No. 4	40	55	387.505 / 0004
keyed alike No. 4	40	60	387.506 / 0004
keyed alike No. 4	40	65	389.598 / 0004
keyed alike No. 4	40	70	389.599 / 0004
keyed alike No. 4	45	45	387.507 / 0004
keyed alike No. 4	45	50	387.508 / 0004
keyed alike No. 4	45	55	387.509 / 0004
keyed alike No. 4	45	60	387.510 / 0004
keyed alike No. 4	45	65	387.511 / 0004
keyed alike No. 4	50	50	387.512 / 0004
keyed alike No. 4	50	55	389.600 / 0004
keyed alike No. 4	50	60	389.601 / 0004

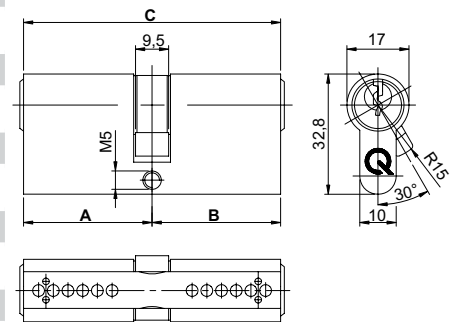

# DOOR HARDWARE

## Profile cylinder keyed alike No. 4

### greenteQ Profile half cylinder SX 8-F keyed alike No. 4

greenteQ profile half cylinder SX 8-F are made off brass matt nickel-plated and the standard cylinder has a 6 pin system. They are tested and certified according to EN 1303:2005/AC:2008, have an 8-fold adjustable cam and have a drilling protection, core extraction protection as well as anti-picking. The basic length of the greenteQ profile half cylinders SX 8-F is 30 mm; available extensions at one side by 5 mm are possible. The cylinders are delivered with 3 keys.

#### Instruction manual for the 8-fold adjustable cam:

New functionality of greenteQ profile half cylinder SX 8-F: The lock cam is at an angle of 45° 8-fold adjustable, so that the cylinder is usable in various installation situations (lockable window handles, key switch etc.).

This is how it works:

Press the thrust bolt on the back of the cylinder with a pointed object (key, fixing screw etc.); turn the lock cam in the desired position; release the thrust bolt; the thrust bolt engages then automatically.

#### Technical data:

- Material of profile cylinder: brass
- Surface: satin nickel-plated
- Pins: 6
- Emergency function: yes
- Certification acc. to: EN 1303:2005/AC:2008; FZG 2010\_01
- Closure: 8-way adjustable
- Keys: 3
- Fixing screw: 1 x M5 x 50 mm and 1 x M5 x 80 mm

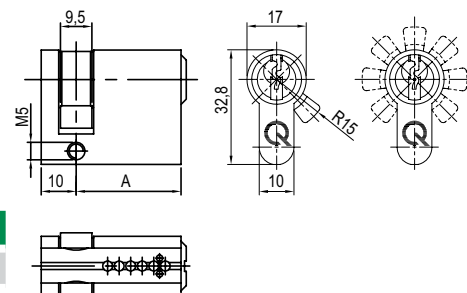

Keyed alike	Length A	VBH Article-No.	
keyed alike No. 4	30	392.794 / 0004	
keyed alike No. 4	35	392.795 / 0004	
keyed alike No. 4	40	392.796 / 0004	
keyed alike No. 4	45	392.797 / 0004	
keyed alike No. 4	50	392.798 / 0004	
keyed alike No. 4	55	395.476 / 0004	
keyed alike No. 4	60	395.477 / 0004	
keyed alike No. 4	65	395.478 / 0004	
keyed alike No. 4	70	395.479 / 0004	

### greenteQ Additional change key keyed alike No. 4

greenteQ additional change key for greenteQ profile double cylinder SX, SX greenteQ profile half-cylinder 8-F, greenteQ Profile knob cylinder SX.

Keyed alike	PU	VBH Article-No.	
keyed alike No. 4	1 pc.	389.646 / 0004	



# DOOR HARDWARE

## Profile cylinder keyed alike No. 5

### greenteQ Profile double cylinder SX GF Keyed alike No. 5

greenteQ profile double cylinder SX; standard profil, 6 pin system; emergency function (bilateral opening); certification according to EN 1303 : 2005; drilling protection; core extraction protection; anti-picking; basic length 30/30 mm; deliverable extensions at one side or both sides each by 5 mm possible; supplied with 3 keys; brass matt nickel-plated.

#### Technical data:

- Material of profile cylinder: brass
- Surface: satin nickel-plated
- Pins: 6
- Emergency function: yes
- Certification acc. to: EN 1303:2005/AC:2008; FZG 2010\_01
- Closure: 8-way adjustable
- Keys: 3
- Fixing screw: 1 x M5 x 50 mm and 1 x M5 x 80 mm



Keyed alike	Length A	Length B	VBH Article-No.
keyed alike No. 5	30	30	387.487 / 0005
keyed alike No. 5	30	35	387.488 / 0005
keyed alike No. 5	30	40	387.489 / 0005
keyed alike No. 5	30	45	387.490 / 0005
keyed alike No. 5	30	50	387.491 / 0005
keyed alike No. 5	30	55	387.492 / 0005
keyed alike No. 5	30	60	387.493 / 0005
keyed alike No. 5	30	65	395.483 / 0005
keyed alike No. 5	30	70	395.484 / 0005
keyed alike No. 4	30	75	999.990 / 2027
keyed alike No. 5	35	35	387.494 / 0005
keyed alike No. 5	35	40	387.495 / 0005
keyed alike No. 5	35	45	387.496 / 0005
keyed alike No. 5	35	50	387.497 / 0005
keyed alike No. 5	35	55	387.498 / 0005
keyed alike No. 5	35	60	387.499 / 0005
keyed alike No. 5	35	65	387.500 / 0005
keyed alike No. 5	35	70	387.501 / 0005
keyed alike No. 5	40	40	387.502 / 0005
keyed alike No. 5	40	45	387.503 / 0005
keyed alike No. 5	40	50	387.504 / 0005
keyed alike No. 5	40	55	387.505 / 0005
keyed alike No. 5	40	60	387.506 / 0005
keyed alike No. 5	40	65	389.598 / 0005
keyed alike No. 5	40	70	389.599 / 0005
keyed alike No. 5	45	45	387.507 / 0005
keyed alike No. 5	45	50	387.508 / 0005
keyed alike No. 5	45	55	387.509 / 0005
keyed alike No. 5	45	60	387.510 / 0005
keyed alike No. 5	45	65	387.511 / 0005
keyed alike No. 5	50	50	387.512 / 0005
keyed alike No. 5	50	55	389.600 / 0005
keyed alike No. 5	50	60	389.601 / 0005

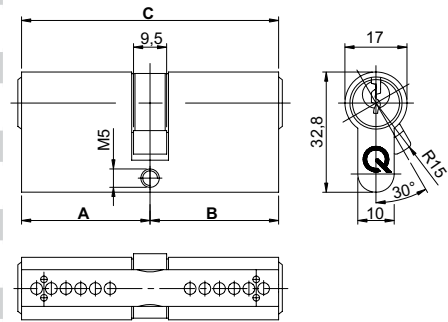



# DOOR HARDWARE

## Profile cylinder keyed alike No. 5

### greenteQ Profile half cylinder SX 8-F keyed alike No. 5

greenteQ profile half cylinder SX 8-F are made off brass matt nickel-plated and the standard cylinder has a 6 pin system. They are tested and certified according to EN 1303:2005/AC:2008, have an 8-fold adjustable cam and have a drilling protection, core extraction protection as well as anti-picking. The basic length of the greenteQ profile half cylinders SX 8-F is 30 mm; available extensions at one side by 5 mm are possible. The cylinders are delivered with 3 keys.

#### Instruction manual for the 8-fold adjustable cam:

New functionality of greenteQ profile half cylinder SX 8-F: The lock cam is at an angle of 45° 8-fold adjustable, so that the cylinder is usable in various installation situations (lockable window handles, key switch etc.).

This is how it works:

Press the thrust bolt on the back of the cylinder with a pointed object (key, fixing screw etc.); turn the lock cam in the desired position; release the thrust bolt; the thrust bolt engages then automatically.

#### Technical data:

- Material of profile cylinder: brass
- Surface: satin nickel-plated
- Pins: 6
- Emergency function: yes
- Certification acc. to: EN 1303:2005/AC:2008; FZG 2010\_01
- Closure: 8-way adjustable
- Keys: 3
- Fixing screw: 1 x M5 x 50 mm and 1 x M5 x 80 mm

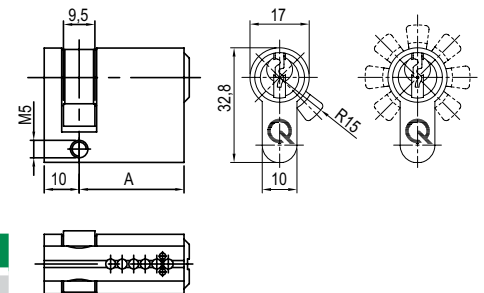

Keyed alike	Length A	VBH Article-No.	
keyed alike No. 5	30	392.794 / 0005	
keyed alike No. 5	35	392.795 / 0005	
keyed alike No. 5	40	392.796 / 0005	
keyed alike No. 5	45	392.797 / 0005	
keyed alike No. 5	50	392.798 / 0005	
keyed alike No. 5	55	395.476 / 0005	
keyed alike No. 5	60	395.477 / 0005	
keyed alike No. 5	65	395.478 / 0005	
keyed alike No. 5	70	395.479 / 0005	

### greenteQ Additional change key keyed alike No. 5

greenteQ additional change key for greenteQ profile double cylinder SX, SX greenteQ profile half-cylinder 8-F, greenteQ Profile knob cylinder SX.

Keyed alike	PU	VBH Article-No.	
keyed alike No. 5	1 pc.	389.646 / 0005	



# DOOR HARDWARE

## Profile cylinder WC

### greenteQ WC knob cylinder SX

greenteQ WC knob cylinder SX is made of brass matt nickel-plated. The greenteQ WC knob cylinder SX can be opened in the emergency with a flat object from the outside. Two lengths of greenteQ WC knob cylinder SX, 32,5 / 32,5K mm and 35 / 35K mm, are available.

#### Technical data:

- Material of profile cylinder: brass
- Surface: satin nickel-plated
- Emergency function: -
- Fixing screw: 1 x M5 x 50 mm and 1 x M5 x 80 mm

Length A	Length B	VBH Article-No.
32.5	32.5	398.383 / 0000 
35	35	398.382 / 0000 

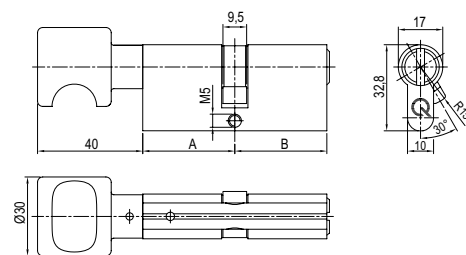

### greenteQ WC knob half cylinder SX

greenteQ WC knob half cylinder SX is made of brass matt nickel-plated. One length of greenteQ WC knob cylinder SX 35 is available.

#### Technical data:

- Material of profile cylinder: brass
- Surface: satin nickel-plated
- Emergency function: -
- Fixing screw: 1 x M5 x 50 mm and 1 x M5 x 80 mm

Length A	Length B	VBH Article-No.
35	-	398.384 / 0000 

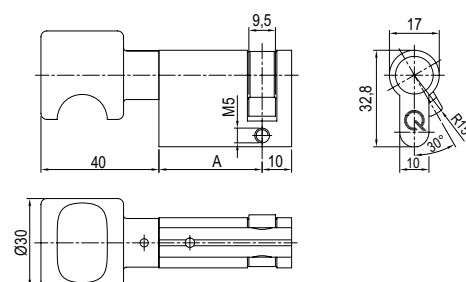

# DOOR HARDWARE

## Escutcheon

### greenteQ Escutcheon 25 mm

greenteQ Escutcheon 25 mm ER is made of stainless steel with a diameter of 25 mm. The drilling for greenteQ Escutcheon 25 mm ER must be 21+0,05 mm in diameter. greenteQ Escutcheon 25 mm ER should be ensured with the adhesive.

Material	Diameter	Fastening	PU	VBH Article-No.
Stainless steel	21+0,05 mm	with adhesive	1 pc.	402.689 / 6500

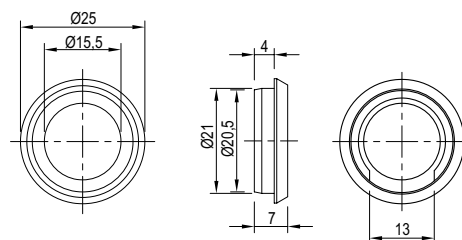

### greenteQ Escutcheon 35 mm

greenteQ Escutcheon 35 mm ER with self adhesive is made of stainless steel with a diameter of 35mm. The drilling for greenteQ Escutcheon 35 mm ER with self adhesive must be 21+0,05 mm in diameter. The fixing is made by means of the self adhesive at the rear edge.

Material	Diameter	Fastening	PU	VBH Article-No.
Stainless steel	21+0,05 mm	self adhesive	1 pc.	402.690 / 6500

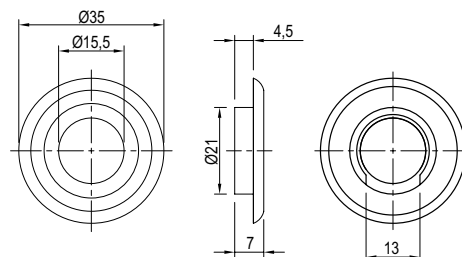

# DOOR HARDWARE

## Front door seals

### greenteQ Front Door Seal TPE-V

greenteQ front door seals consist of high-quality TPE-V material (highly crosslinked EPDM-X+PP) in the function elements seal head and foot-retainer lip. The basic structure and the easy-cleaning, coloured special coating are produced from TPE-S material. The linear closing pressure is very low, with a high range of action (high tolerance equalisation). The materials are compatible with all common painting systems. Unknown paints and coatings must be tested for compatibility in terms of their contact with the seal profiles.

greenteQ front door seals are temperature resistant from - 40°C up to +80°C as well as resistant to ageing, weather, UV and ozone. They have very good physical features, are free from PVC and do not contain softeners or silicone.

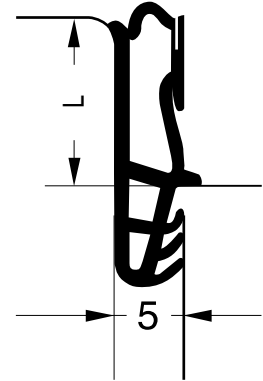

Fold height	Surface	PU	VBH Article-No.
12 mm	black similar to RAL 9017	100 m	180.035 / 0001
12 mm	white similar to RAL 9016	100 m	180.035 / 0002
12 mm	grey similar to RAL 7040	100 m	180.035 / 0003
12 mm	brown similar to RAL 8002	100 m	180.035 / 0004
12 mm	beige similar to RAL 1001	100 m	180.035 / 0005
15 mm	black similar to RAL 9017	100 m	180.036 / 0001
15 mm	white similar to RAL 9016	100 m	180.036 / 0002
15 mm	grey similar to RAL 7040	100 m	180.036 / 0003
15 mm	brown similar to RAL 8002	100 m	180.036 / 0004
15 mm	beige similar to RAL 1001	100 m	180.036 / 0005
18 mm	black similar to RAL 9017	100 m	180.037 / 0001
18 mm	white similar to RAL 9016	100 m	180.037 / 0002
18 mm	grey similar to RAL 7040	100 m	180.037 / 0003
18 mm	brown similar to RAL 8002	100 m	180.037 / 0004
18 mm	beige similar to RAL 1001	100 m	180.037 / 0005



# DOOR HARDWARE

## Door hinges for PVC doors (house doors)

### greenteQ Door hinge TB 100.ZD.K

With the new greenteQ TB 100.ZD.K door hinge, VBH presents a 3-dimensionally adjustable door hinge for PVC doors with a sash weight up to 100 kg for house doors which are subject to heavy stress and frequent use. The name TB 100.ZD.K stands for: door hinge - 100 kg - made of zinc diecasting - for PVC doors. The bands can be used for doors which open inwards or outwards, can be mounted on the left or right, and have a simple stop and easy adjustment. The greenteQ door hinges are available in white RAL 9016, brown RAL 8019, PVD chrome polished, PVD gold polished or silver (RAL 9006). The constructional moulding in zinc diecasting was designed to ensure maximum strength in the main areas of stress. The door hinge is certified in accordance with EN 1935.

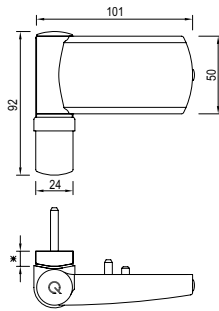

#### Technical data:

- Material: Zinc diecasting
- Bearing capacity: 100 kg
- Frame component: 19 mm exposure height
- Lateral adjustment: +5 / -5 mm
- Vertical adjustment: +4 / -1 mm
- Closing pressure adjustment: +1.5 / -1.5 mm
- Certified in accordance with: EN1935 | 4 | 7 | 5 | 0 | 1 | 1 | 4 | 0 | 1 | 2 |

For direct mounting, please use a greenteQ drilling jig made of aluminium or polyamide, with hardened steel bushings





Material	Surface	Colour code	Upstand height (*)	VBH Article-No.
Zinc die-cast	silver similar to 9006	Q9006	13.5 - 16.5 mm	391.646 / 0100
Zinc die-cast	silver similar to 9006	Q9006	18.5 - 21.5 mm	391.647 / 0100
Zinc die-cast	brown	RAL 8019	13.5 - 16.5 mm	391.646 / 0900
Zinc die-cast	brown	RAL 8019	18.5 - 21.5 mm	391.647 / 0900
Zinc die-cast	white	RAL 9016	13.5 - 16.5 mm	391.646 / 1000
Zinc die-cast	white	RAL 9016	18.5 - 21.5 mm	391.647 / 1000
Zinc die-cast	PVD chrome polished	PVD-C	13.5 - 16.5 mm	391.646 / 4210
Zinc die-cast	PVD chrome polished	PVD-C	18.5 - 21.5 mm	391.647 / 4210
Zinc die-cast	PVD gold polished	PVD-G	13.5 - 16.5 mm	391.646 / 7110
Zinc die-cast	PVD gold polished	PVD-G	18.5 - 21.5 mm	391.647 / 7110
Zinc die-cast	pearl gold	RAL 1036	13.5 - 16.5 mm	391.646 / 1036
Zinc die-cast	pearl gold	RAL 1036	18.5 - 21.5 mm	391.647 / 1036

# DOOR HARDWARE

## Door hinges for PVC doors (house doors)

### greenteQ Set of plastic accessories TB 100.ZD.K





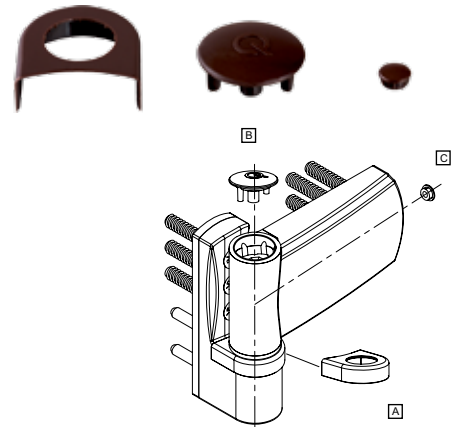











greenteQ set of plastic accessories TB 100.ZD.K is usable as spare parts in case of loss or damage during the assembly of greenteQ door hinge TB 100.ZD.K. The set of plastic accessories is available in the colours white, brown, gold or chrome/silver.

Material	Surface	PU	VBH Article-No.
Plastic (Nylon)	white	100 sets	395.356 / 1000 
Plastic (Nylon)	brown	100 sets	395.356 / 0900 
Plastic (Nylon)	chrome/silver	100 sets	395.356 / 4200 
Plastic (Nylon)	gold	100 sets	395.356 / 7100 



### greenteQ Packer for door hinge TB 100.ZD.K

greenteQ packer for door-hinge to adjust different upstand heights.  
greenteQ packer for TB 80.ZD.K door hinge and TB 100.ZD.K door hinge; plastic; thickness: 1 mm, 2 mm, 3 mm or 5 mm; white, brown, chrome/silver or gold.

Material	Surface	Strength	PU	VBH Article-No.
Plastic	white	1 mm	100 pcs.	386.672 / 1000 
Plastic	white	2 mm	100 pcs.	386.673 / 1000 
Plastic	white	3 mm	100 pcs.	389.890 / 1000 
Plastic	white	5 mm	100 pcs.	389.891 / 1000 
Plastic	brown	1 mm	100 pcs.	386.672 / 0900 
Plastic	brown	2 mm	100 pcs.	386.673 / 0900 
Plastic	brown	3 mm	100 pcs.	389.890 / 0900 
Plastic	brown	5 mm	100 pcs.	389.891 / 0900 
Plastic	chrome/silver	1 mm	100 pcs.	386.672 / 4200 
Plastic	chrome/silver	2 mm	100 pcs.	386.673 / 4200 
Plastic	chrome/silver	3 mm	100 pcs.	389.890 / 4200 
Plastic	chrome/silver	5 mm	100 pcs.	389.891 / 4200 
Plastic	gold	1 mm	100 pcs.	386.672 / 7100 
Plastic	gold	2 mm	100 pcs.	386.673 / 7100 
Plastic	gold	3 mm	100 pcs.	389.890 / 7100 
Plastic	gold	5 mm	100 pcs.	389.891 / 7100 

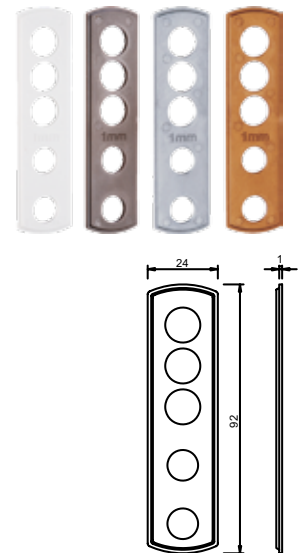

### greenteQ Fastening set TB 100.ZD.K

greenteQ set of screws TB 100.ZD.K for the door hinge TB 100.ZD.K is usable as spare parts in case of loss or damage during the assembly of greenteQ door hinge TB 100.ZD.K.

Dimension d x L	Upstand height	PU	VBH Article-No.
6.3 x 40 mm (7 pieces) and 6.3 x 28 mm (2 pieces)	13.5 - 21.5 mm	1 set	395.358 / 0000 



# DOOR HARDWARE

## Door hinges for PVC doors (house doors)

### greenteQ Fastening set TB 100.ZD.K long

50 mm long screws for the frame part of the door hinge TB 100.ZD.K, with the use of tape-records for frame profiles with low center of reinforcement.

Dimension d x L	Upstand height	PU	VBH Article-No.
6.3 x 50 mm (3 pieces)	13.5 - 21.5 mm	1 set	390.898 / 0000 



### greenteQ Drilling jig TB 100.ZD.K

greenteQ drilling jig for door hinge TB 100.ZD.K; aluminium or polyamide, with hardened steel bushings

Material	PU	VBH Article-No.
Aluminium	1 pc.	386.674 / 0000 
Polyamide 6,6	1 pc.	389.145 / 0000 



# DOOR HARDWARE

## Door hinges for PVC doors (house doors)

### greenteQ Door hinge TB 120.ZD.K \*new\*

With the new greenteQ TB 120.ZD.K door hinge, VBH presents a 3-dimensionally adjustable door hinge for PVC doors with a sash weight up to 120 kg for house doors which are subject to heavy stress and frequent use. The name TB 120.ZD.K stands for: door hinge - 120 kg - made of zinc diecasting - for PVC doors. The bands can be used for doors which open inwards or outwards, can be mounted on the left or right, and have a simple stop and easy adjustment. The greenteQ door hinges are available in white RAL 9016, brown RAL 8019, PVD chrome polished, PVD gold polished or silver (RAL 9006). The constructional moulding in zinc diecasting was designed to ensure maximum strength in the main areas of stress. The door hinge is certified in accordance with EN 1935.

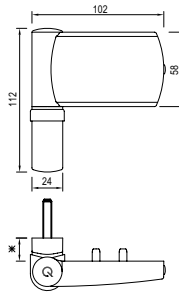

#### Technical data:

- Material: Zinc diecasting
- Bearing capacity: 120 kg
- Frame component: 19 mm exposure height
- Lateral adjustment: +5 / -5 mm
- Vertical adjustment: +4 / -1 mm
- Closing pressure adjustment: +1.5 / -1.5 mm
- Certified in accordance with: EN1935 | 4 | 7 | 6 | 0 | 1 | 1 | 4 | 0 | 1 | 3 |

For direct mounting, please use a greenteQ drilling jig made of aluminium or polyamide, with hardened steel bushings

Material	Surface	Colour code	Upstand height (*)	VBH Article-No.
Zinc die-cast	silver similar to 9006	Q9006	16.5 - 19.5 mm	399.410 / 0100
Zinc die-cast	silver similar to 9006	Q9006	19.5 - 22.5 mm	399.412 / 0100
Zinc die-cast	silver similar to 9006	Q9006	22.5 - 25.5 mm	399.413 / 0100
Zinc die-cast	brown	RAL 8019	16.5 - 19.5 mm	399.410 / 0900
Zinc die-cast	brown	RAL 8019	19.5 - 22.5 mm	399.412 / 0900
Zinc die-cast	brown	RAL 8019	22.5 - 25.5 mm	399.413 / 0900
Zinc die-cast	white	RAL 9016	16.5 - 19.5 mm	399.410 / 1000
Zinc die-cast	white	RAL 9016	19.5 - 22.5 mm	399.412 / 1000
Zinc die-cast	white	RAL 9016	22.5 - 25.5 mm	399.413 / 1000
Zinc die-cast	PVD chrome polished	PVD-C	16.5 - 19.5 mm	399.410 / 4210
Zinc die-cast	PVD chrome polished	PVD-C	19.5 - 22.5 mm	399.412 / 4210
Zinc die-cast	PVD chrome polished	PVD-C	22.5 - 25.5 mm	399.413 / 4210
Zinc die-cast	PVD gold polished	PVD-G	16.5 - 19.5 mm	399.410 / 7110
Zinc die-cast	PVD gold polished	PVD-G	19.5 - 22.5 mm	399.412 / 7110
Zinc die-cast	PVD gold polished	PVD-G	22.5 - 25.5 mm	399.413 / 7110
Zinc die-cast	pearl gold	RAL 1036	16.5 - 19.5 mm	399.410 / 1036
Zinc die-cast	pearl gold	RAL 1036	19.5 - 22.5 mm	399.412 / 1036
Zinc die-cast	pearl gold	RAL 1036	22.5 - 25.5 mm	399.413 / 1036







# DOOR HARDWARE

## Door hinges for PVC doors (house doors)

### greenteQ Set of plastic accessories TB 120.ZD.K





greenteQ set of plastic accessories TB 120.ZD.K is usable as spare parts in case of loss or damage during the assembly of greenteQ door hinge TB 120.ZD.K. The set of plastic accessories is available in the colours white, brown, gold or chrome/silver.

Material	Surface	PU	VBH Article-No.
Plastic (Nylon)	white	100 sets	395.357 / 1000 
Plastic (Nylon)	brown	100 sets	395.357 / 0900 
Plastic (Nylon)	chrome/silver	100 sets	395.357 / 4200 
Plastic (Nylon)	gold	100 sets	395.357 / 7100 



### greenteQ Packer for door hinge TB 120.ZD.K

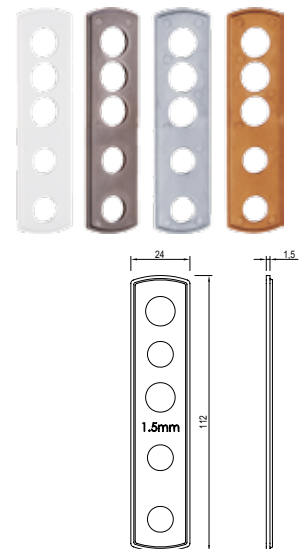

greenteQ packer for door-hinge to adjust different upstand heights. greenteQ Packer for greenteQ door hinge TB 120.ZD.K is made of plastic and has a thickness of 1.5 mm. The packer is available in the colours white, brown, gold and chrome/silver.

Material	Surface	Strength	PU	VBH Article-No.
Plastic	white	1.5 mm	100 pcs.	391.842 / 1000 
Plastic	brown	1.5 mm	100 pcs.	391.842 / 0900 
Plastic	chrome/silver	1.5 mm	100 pcs.	391.842 / 4200 
Plastic	gold	1.5 mm	100 pcs.	391.842 / 7100 



### greenteQ Fastening set TB 120.ZD.K

greenteQ set of screws TB 120.ZD.K for the door hinge TB 120.ZD.K is usable as spare parts in case of loss or damage during the assembly of greenteQ door hinge TB 120.ZD.K.

Dimension d x L	Upstand height	PU	VBH Article-No.
7.3 x 40 mm (4 pieces) and 7.3 x 45 mm (2 pieces)	16.5 - 19.5 mm	1 set	395.359 / 1619 
7.3 x 40 mm (4 pieces) and 7.3 x 48 mm (2 pieces)	19.5 - 22.5 mm	1 set	395.359 / 1922 
7.3 x 40 mm (4 pieces) and 7.3 x 53 mm (2 pieces)	22.5 - 25.5 mm	1 set	395.359 / 2225 



# DOOR HARDWARE

## Door hinges for PVC doors (house doors)

### greenteQ Drilling jig TB 120.ZD.K adjustable

greenteQ drilling jig TB 120.ZD.K adjustable is made for simultaneous fitting of sash and frame. With the adjustable guiding rail and the adjustable drilling slider it is possible to adjust the positions of screws and the centering pin according to the used door profile and the reinforcement. It is equipped with hardened bushes.

Material	PU	VBH Article-No.
Polyamide 6,6	1 pc.	394.304 / 0000 



### greenteQ Telescopic bar for adjustable jig TB 120.ZD.K

The telescoping bar to jig greenteQ 120.ZD.K adjustable TB is made of aluminum and is adjustable along with 3 TB 120.ZD.K greenteQ jigs (not included), can be used as telescoping bar for mounting the door hinges greenteQ TB 120.ZD.K. Adjustable with the telescoping rod to jig greenteQ 120.ZD.K TB after a single establishment of the upper and lower stops is possible a simple, quick, and consistent positioning of the door hinges to the frame and sash - no need for repeated measuring and marking.

#### Technical data:

- Material Telescopic bar: Aluminium
- Material support for greenteQ jig TB 120.ZD.K: Aluminium
- Material threaded rod height stop: Stainless steel
- Material height angle stop: Aluminium
- Length Telescopic bar: 2,405 mm
- Maximum extension length (threaded bar and stop): 2,700 mm
- Fastening (hexagon head screw): 2 x M5 x 10mm and 12 x M5 x 15mm

Material	PU	VBH Article-No.
Aluminium / Stainless steel	1 pc.	394.305 / 0000 







# DOOR HARDWARE

## Supplementary range

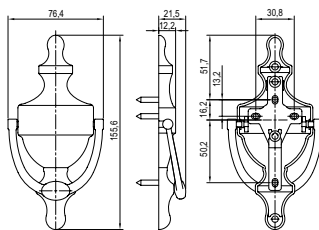
### greenteQ Door knockers

greenteQ door knockers for a careful knocking on entrance doors of flats and houses. It can be mounted additionally or in frame for a bell. The greenteQ door knocker delivered without hole or with hole. The hole is an apparatus for a door viewer. The greenteQ door knocker is supplied without screws. It's made of zinc die-casting method. Fixing screws (not included): Pan head screws (4 pieces), e.g. 4,2x22 mm.





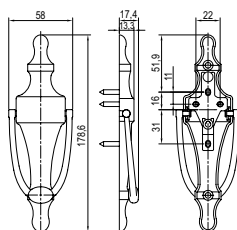

Material	Surface	Colour code	Variants	PU	VBH Article-No.
Zinc die-cast	black	Q9011	without hole	1 pc.	390.811 / 0800 
Zinc die-cast	white	Q9016	without hole	1 pc.	390.811 / 1000 
Zinc die-cast	PVD chrome polished	PVD-C	without hole	1 pc.	390.811 / 4210 
Zinc die-cast	PVD gold polished	PVD-G	without hole	1 pc.	390.811 / 7110 

### greenteQ Door knocker slim

greenteQ door knockers for a careful knocking on entrance doors of flats and houses. It can be mounted additionally or in frame for a bell. The greenteQ door knocker delivered without hole or with hole. The hole is an apparatus for a door viewer. The greenteQ door knocker is supplied without screws. Fixing screws (not included): Pan head screws (4 pieces), e.g. 4,2x22 mm.





Material	Surface	Colour code	Variants	PU	VBH Article-No.
Zinc die-cast	black	Q9011	slim without hole	1 pc.	390.813 / 0800 
Zinc die-cast	white	Q9016	slim without hole	1 pc.	390.813 / 1000 
Zinc die-cast	PVD chrome polished	PVD-C	slim without hole	1 pc.	390.813 / 4210 
Zinc die-cast	PVD gold polished	PVD-G	slim without hole	1 pc.	390.813 / 7110 

### greenteQ Door knocker with hole

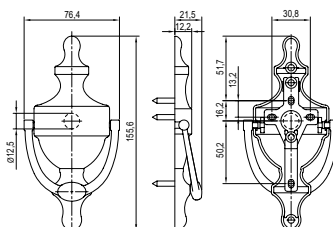
greenteQ door knockers for a careful knocking on entrance doors of flats and houses. It can be mounted additionally or in frame for a bell. The greenteQ door knocker delivered without hole or with hole. The hole is an apparatus for a door viewer. The greenteQ door knocker is supplied without screws. It's made of zinc die-casting method. Fixing screws (not included): Pan head screws (4 pieces), e.g. 4,2x22 mm.



Material	Surface	Colour code	Variants	PU	VBH Article-No.
Zinc die-cast	PVD chrome polished	PVD-C	with hole	1 pc.	390.812 / 4210 
Zinc die-cast	PVD gold polished	PVD-G	with hole	1 pc.	390.812 / 7110 

# DOOR HARDWARE



## Supplementary range

### greenteQ Door knocker slim with hole

greenteQ door knockers for a careful knocking on entrance doors of flats and houses. It can be mounted additionally or in frame for a bell. The greenteQ door knocker delivered without hole or with hole. The hole is an apparatus for a door viewer. The greenteQ door knocker is supplied without screws.

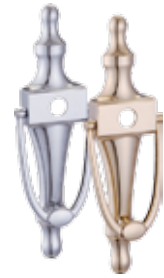
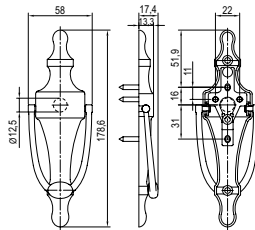
Fixing screws (not included): Pan head screws (4 pieces), e.g. 4,2x22 mm.







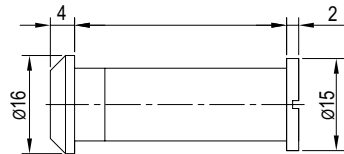

Material	Surface	Colour code	Variants	PU	VBH Article-No.
Zinc die-cast	PVD chrome polished	PVD-C	slim with hole	1 pc.	390.814 / 4210 
Zinc die-cast	PVD gold polished	PVD-G	slim with hole	1 pc.	390.814 / 7110 

### greenteQ Door viewer

The greenteQ door viewer is suitable for a bore diameter of 12 mm and for a door thickness from 35 - 60 mm or 60 - 85 mm. The angle of view amounts 160°. The greenteQ door viewer is made of brass.



Material	Surface	Colour code	Door thickness	PU	VBH Article-No.
Brass	PVD chrome polished	PVD-C	25 - 40 mm	1 pc.	403.170 / 4210 
Brass	PVD gold polished	PVD-G	25 - 40 mm	1 pc.	403.170 / 7110 
Brass	PVD chrome polished	PVD-C	35 - 60 mm	1 pc.	390.809 / 4210 
Brass	PVD gold polished	PVD-G	35 - 60 mm	1 pc.	390.809 / 7110 
Brass	PVD chrome polished	PVD-C	60 - 85 mm	1 pc.	390.810 / 4210 
Brass	PVD gold polished	PVD-G	60 - 85 mm	1 pc.	390.810 / 7110 

# DOOR HARDWARE

## Supplementary range

### greenteQ Signs Ladies

greenteQ self-sticking signs, made of stainless steel, matt brushed, for use on smooth surfaces, interior and exterior. With different symbols and signs.  
greenteQ sign; diameter 76mm; self-sticking; stainless steel matt brushed.

Variants	Material	Surface	PU	VBH Article-No.
"Ladies"	Stainless steel	matt brushed	1 pc.	376.925 / 0000 



### greenteQ Signs Gentlemen

greenteQ self-sticking signs, made of stainless steel, matt brushed, for use on smooth surfaces, interior and exterior. With different symbols and signs.  
greenteQ sign; diameter 76mm; self-sticking; stainless steel matt brushed.

Variants	Material	Surface	PU	VBH Article-No.
"Gentlemen"	Stainless steel	matt brushed	1 pc.	376.926 / 0000 



### greenteQ Signs WC

greenteQ self-sticking signs, made of stainless steel, matt brushed, for use on smooth surfaces, interior and exterior. With different symbols and signs.  
greenteQ sign; diameter 76mm; self-sticking; stainless steel matt brushed.

Variants	Material	Surface	PU	VBH Article-No.
"WC"	Stainless steel	matt brushed	1 pc.	376.927 / 0000 



### greenteQ Signs Wheelchair

greenteQ self-sticking signs, made of stainless steel, matt brushed, for use on smooth surfaces, interior and exterior. With different symbols and signs.  
greenteQ sign; diameter 76mm; self-sticking; stainless steel matt brushed.

Variants	Material	Surface	PU	VBH Article-No.
"Wheelchair"	Stainless steel	matt brushed	1 pc.	376.928 / 0000 



### greenteQ Signs Nonsmoker

greenteQ self-sticking signs, made of stainless steel, matt brushed, for use on smooth surfaces, interior and exterior. With different symbols and signs.  
greenteQ sign; diameter 76mm; self-sticking; stainless steel matt brushed.

Variants	Material	Surface	PU	VBH Article-No.
"Nonsmoker"	Stainless steel	matt brushed	1 pc.	376.929 / 0000 



# DOOR HARDWARE

## Supplementary range

### greenteQ Signs PULL

greenteQ self-sticking signs, made of stainless steel, matt brushed, for use on smooth surfaces, interior and exterior. With different symbols and signs.  
greenteQ sign; diameter 76mm; self-sticking; stainless steel matt brushed.

Variants	Material	Surface	PU	VBH Article-No.
"Pull"	Stainless steel	matt brushed	1 pc.	376.930 / 0000 



### greenteQ Signs PUSH

greenteQ self-sticking signs, made of stainless steel, matt brushed, for use on smooth surfaces, interior and exterior. With different symbols and signs.  
greenteQ sign; diameter 76mm; self-sticking; stainless steel matt brushed.

Variants	Material	Surface	PU	VBH Article-No.
"Push"	Stainless steel	matt brushed	1 pc.	376.931 / 0000 





### greenteQ Floor doorstop

greenteQ floor doorstop; diameter 70 mm; height 21 mm; with dowel and screw; stainless steel matt brushed.

#### Technical data:

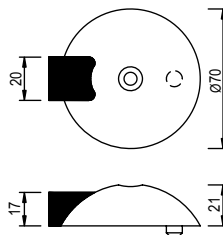
- Diameter: 70 mm
- Height: 21 mm
- Screws: 1 piece countersunk head wood screw 6 x 60 mm with dowel



Material	Surface	PU	VBH Article-No.
Stainless steel	matt brushed	1 pc.	376.035 / 6500 

### greenteQ Wall mounted doorstop

greenteQ wall mounted doorstop; diameter 30 mm; height 25 mm; with dowel and screw; stainless steel matt brushed.

#### Technical data:

- Diameter: 30 mm
- Height: 25 mm
- Screws: 1 piece countersunk head wood screw 5 x 50 mm with dowel

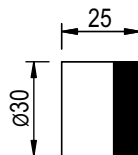

Material	Surface	PU	VBH Article-No.
Stainless steel	matt brushed	1 pc.	376.036 / 6500 

# DOOR HARDWARE

## Supplementary range

### greenteQ House numbers

greenteQ house numbers made of stainless steel, matt brushed, for use on the wall in the building entrance area.

The material stainless steel 1.4301 (AISI 304-A2) has a good corrosion resistance to weathering, is largely resistant to weak acids and building authorities tested and approved for moderate chloride and sulfur dioxide pollution.

Therefore the house numbers are used almost anywhere. Only the use in aggressive environments (e.g. seawater) should be avoided; with dowels and screws; stainless steel matt brushed.

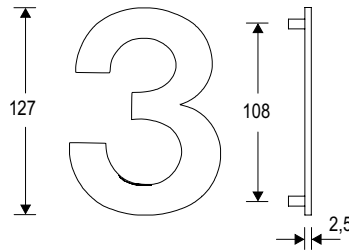

Material	Surface	Variants	PU	VBH Article-No.	
Stainless steel	matt brushed	1	1 pc.	376.032 / 0001	
Stainless steel	matt brushed	2	1 pc.	376.032 / 0002	
Stainless steel	matt brushed	3	1 pc.	376.032 / 0003	
Stainless steel	matt brushed	4	1 pc.	376.032 / 0004	
Stainless steel	matt brushed	5	1 pc.	376.032 / 0005	
Stainless steel	matt brushed	6	1 pc.	376.032 / 0006	
Stainless steel	matt brushed	7	1 pc.	376.032 / 0007	
Stainless steel	matt brushed	8	1 pc.	376.032 / 0008	
Stainless steel	matt brushed	9	1 pc.	376.032 / 0009	
Stainless steel	matt brushed	0	1 pc.	376.032 / 0000	

### greenteQ Pro weldable corner connector

The greenteQ pro weldable corner connector consists of a basic body and a clamping element (tab). It serves in door frame production as the connecting element for the steel reinforcement in the PVC profile. The square galvanized steel tubes within the PVC profile are connected to a static load-bearing frame due to the use of the greenteQ pro weldable corner connectors. The greenteQ weldable corner connectors are measured as part of regular quality checks after production both internally on a spot-check basis and externally with regard to quality and dimensional accuracy as part of the Ift certification. The finished door frame has greater stability and ensures the best possible torsional resistance due to the extra-thick wall design and wide tab.

#### Product advantages:

- Simple assembly process
- Optimal force transmission to steel reinforcement due to the complete support of the wedges on the basic body and tab
- Best possible torsional resistance due to the use of greenteQ weldable corner connectors in door frame production
- Min. door frame deformation under load
- Large insertion depth, also in the case of the mitred steel reinforcement
- Straightforward and automatic flush-mounted tensioning element

#### Technical data:

- Wall thickness: 5 mm
- Tap: wide
- Material: Rigid PVC profile sections
- Tensile strength: 40 - 60 MPa
- Young's modulus: 2400 MPa



Version	Dimension	VBH Article-No.
Pro	50x40x2 mm	403.078 / 5042

# DOOR HARDWARE

## Supplementary range

### greenteQ Standard weldable corner connectors

The greenteQ standard weldable corner connector consists of a basic body and a clamping element (tab). It serves in door frame production as the connecting element for the steel reinforcement in the PVC profile. The square galvanized steel tubes within the PVC profile are connected to a static load-bearing frame due to the use of the greenteQ standard weldable corner connectors. The greenteQ weldable corner connectors are measured as part of regular quality checks after production both internally on a spot-check basis and externally with regard to quality and dimensional accuracy as part of the Ift certification. The finished door frame has greater stability and ensures a high torsional resistance due to the thick wall design and wide tab.











#### Product advantages:

- Simple assembly process
- Optimal force transmission to steel reinforcement due to the complete support of the wedges on the basic body and tab
- High torsional resistance due to the use of greenteQ weldable corner connectors in door frame production
- Min. door frame deformation under load
- Large insertion depth, also in the case of the mitred steel reinforcement
- Straightforward and automatic flush-mounted tensioning element

#### Technical data:

- Wall thickness: 3 - 5 mm
- Tap: wide
- Material: Rigid PVC sheet granulate
- Tensile strength: 40 - 60 MPa
- Young's modulus: 2200 MPa

Version	Dimension	VBH Article-No.
Standard	45x45x2 mm	403.076 / 4542 
Standard	50x40x2 mm	403.076 / 5042 
Standard	50x50x2 mm	999.990 / 0266 
Standard	60x40x2 mm	403.076 / 6002 
Standard	60x45x2 mm	403.076 / 6052 
Standard	60x46x2 mm	403.076 / 6042 
Standard	65x45x2 mm	403.076 / 6542 
Standard	50x40x3 mm	403.076 / 5043 
Standard	65x45x3 mm	403.076 / 6543 

### greenteQ Basic weldable corner connector

The greenteQ basic weldable corner connector consists of a basic body and a clamping element (tab). It serves in door frame production as the connecting element for the steel reinforcement in the PVC profile. The square galvanized steel tubes within the PVC profile are connected to a static load-bearing frame due to the use of the greenteQ basic weldable corner connectors. The greenteQ weldable corner connectors are measured as part of regular quality checks after production both internally on a spot-check basis and externally with regard to quality and dimensional accuracy as part of the Ift certification.



#### Product advantages:

- Simple assembly process
- Good torsional resistance due to the use of greenteQ weldable corner connectors in door frame production
- Min. door frame deformation under load
- Large insertion depth, also in the case of the mitred steel reinforcement
- Straightforward and automatic flush-mounted tensioning element

#### Technical data:

- Wall thickness: 3 mm
- Tap: narrow
- Material: Rigid PVC sheet granulate
- Tensile strength: 40 - 60 MPa
- Young's modulus: 2200 MPa

Version	Dimension	VBH Article-No.
Basic	50x40x2 mm	403.077 / 5042 



# DOOR HARDWARE

## Threshold system

### SYSTEM OVERVIEW

One threshold system for all door types:

- Balcony and French front doors
- Single and double jamb
- Opening inwards and outwards

We have been able to decisively increase the system security of the door-threshold combinations for all frame materials (PVC, wood, metal, wood-metal) with this innovative threshold system. Much more than just a high quality threshold is required for an airtight door that will satisfy its users for a long time. Diverse detailed problems must be solved individually. This brochure can be of invaluable support when doing so. Here we provide you with tried-and-tested recommendations for all important optimisation areas.

We cover all frame materials for the balcony door and house door variants in this connection:

- Strike plate solution with corresponding mounting options
- Lower connection optimisation
- System-secure connection of threshold to frame
- Accessibility as per DIN requirements
- Optimal thermal insulation
- Maximum driving rain resistance
- Durability/permanent function
- Improved intrusion protection

VBH customers can realise all these requirements with the content of the VBH brochure "P08 Threshold system". This system includes, amongst other things, the greenteQ Threshold TB (construction depths 70 to 140 mm), the greenteQ Insulating foundation profile (can be combined with heights 30, 50 and 100 mm) as well as greenteQ Filling pieces for processing in plastic profiles, greenteQ Weatherboarding and greenteQ Brush seals. Special requirements can be fulfilled by combining the various elements. The simultaneous use of greenteQ Threshold, greenteQ Weatherboarding and greenteQ Brush seal allows for an extremely high driving rain resistance of 1,050 Pa. Optimal thermal insulation can be achieved in connection with the greenteQ Insulating foundation profile. An adapter is not required during processing thanks to the innovative VBH countermilling solution, which is available to the customer as a tool for all frame materials.

The VBH customers receive all components from a single source and are flexible to complete those with accessories of our reliable partners range of products. The new VBH brochure "P08 Threshold systems" presents a threshold system that, with all of its various solution variants, is in line with market requirements.

Description	
1	greenteQ Threshold TB
2	greenteQ Insulating foundation profile
3	greenteQ Filling pieces
4	greenteQ MS-Polymer
5	Strike plates
6	greenteQ Weatherboarding
7	greenteQ End caps for weatherboarding
8	greenteQ Brush seal
9	Amrum seal
10	Wind stop

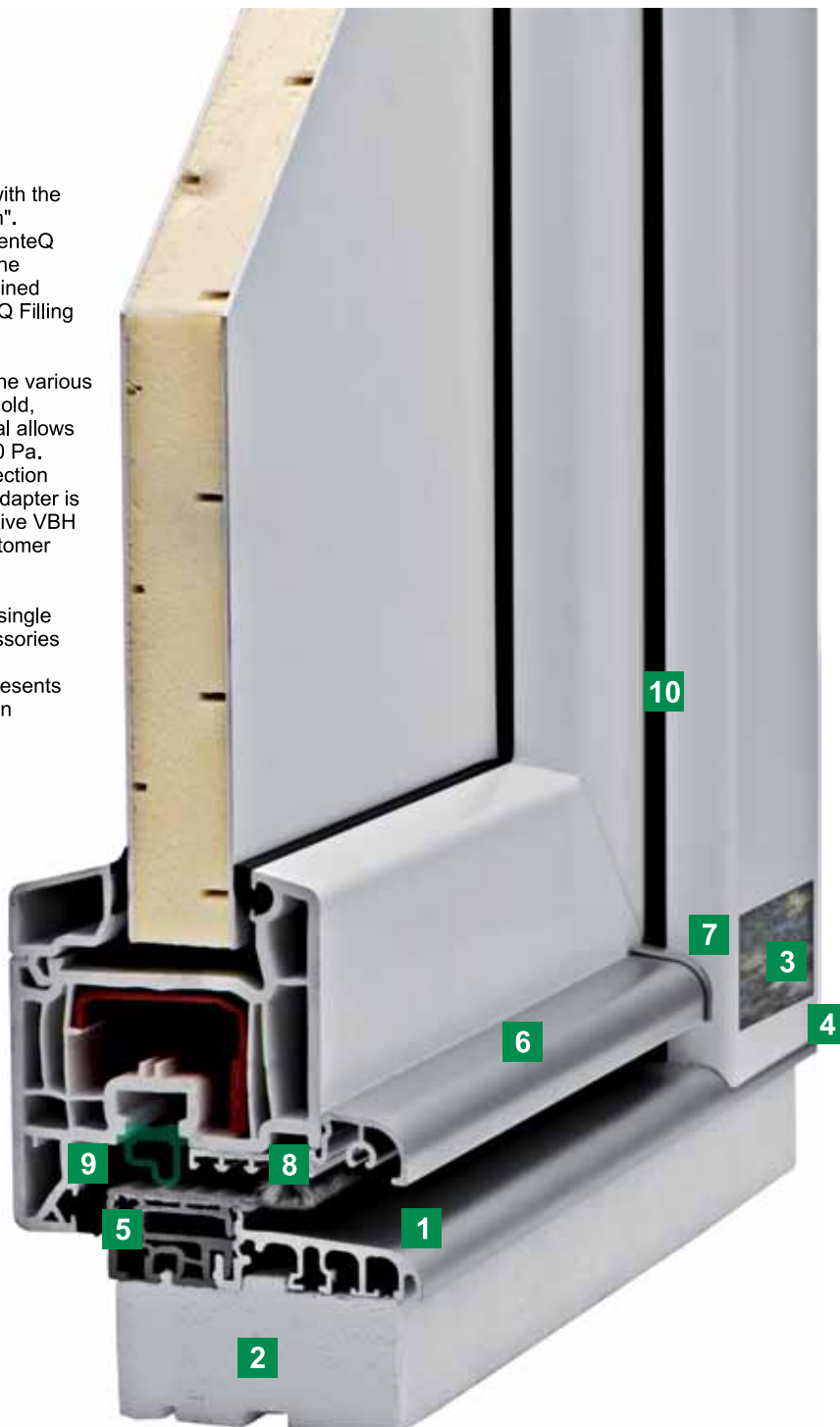



## 10247 Berlin

Eldenaer Str. 35  
Telefon (0 30) 53 14 71-0  
Telefax (0 30) 53 14 71-220  
E-Mail berlin@vbh.de

## 33181 Bad Wünnenberg-Haaren

Graf-Zeppelin-Straße 14  
Telefon (0 52 51) 17 58-0  
Telefax (0 52 51) 17 58-59  
E-Mail paderborn@vbh.de

## 39104 Magdeburg

Schleiufer 18  
Telefon (03 91) 535768-0  
Telefax (0391) 535768-20  
E-Mail magdeburg@vbh.de

## 48432 Rheine

Niemannstr. 9  
Telefon (0 59 71) 7 94-0  
Telefax (0 59 71) 7 94-44  
E-Mail rheine@vbh.de

## 54296 Trier

Max-Planck-Straße 16  
Telefon (06 51) 1 45 64 44  
Telefax (06 51) 1 45 64 43  
E-Mail trier@vbh.de

## 68766 Hockenheim-Talhaus

4. Industriestr. 16  
Telefon (0 62 05) 2 05-0  
Telefax (0 62 05) 2 05-122  
E-Mail hockenheim@vbh.de

## 87437 Kempten

Benzstr. 8  
Telefon (08 31) 70 40-0  
Telefax (08 31) 70 40-141  
E-Mail kempten@vbh.de

## 93057 Regensburg-Haslbach

Weidener Str. 10  
Telefon (09 41) 64 06-0  
Telefax (09 41) 64 06-50  
E-Mail regensburg@vbh.de

## 99092 Erfurt

St.-Christophorus-Str. 5  
Telefon (03 61) 7 77 02 70  
Telefax (03 61) 7 77 02 76  
E-Mail erfurt@vbh.de

## 22113 Hamburg

Amandus-Stubbe-Straße 10  
Telefon (0 40) 21 11 09-0  
Telefax (0 40) 21 11 09-69  
E-Mail hamburg@vbh.de

## 35633 Lahnau

Am Römerlager 4  
Telefon (0 64 41) 6 71 44-0  
Telefax (0 64 41) 6 71 44-52  
E-Mail wetzlar@vbh.de

## 45659 Recklinghausen

Am Stadion 117  
Telefon (0 23 61) 48 01-0  
Telefax (0 23 61) 48 01-110  
E-Mail recklinghausen@vbh.de

## 50996 Köln-Rodenkirchen

Wankelstr. 20  
Telefon (0 22 36) 6 05-0  
Telefax (0 22 36) 6 05-200  
E-Mail koeln@vbh.de

## 66115 Saarbrücken-Malstatt

Im Rotfeld 22  
Telefon (06 81) 9 70 27-0  
Telefax (06 81) 9 70 27-23  
E-Mail saarbruecken@vbh.de

## 70825 Korntal-Münchingen

Siemensstr. 38  
Telefon (0 71 50) 15-0  
Telefax (0 71 50) 15-315  
E-Mail korntal-muenchingen@vbh.de

## 84503 Altötting

Oskar-von-Miller-Str. 6  
Telefon (0 86 71) 50 61-0  
Telefax (0 86 71) 50 61-27  
E-Mail altoetting@vbh.de

## 92690 Pressath

Eschenbacher Str. 8  
Telefon (0 96 44) 6 81-0  
Telefax (0 96 44) 6 81-10  
E-Mail pressath@vbh.de

## 97076 Würzburg

Friedrich-Bergius-Ring 52  
Telefon (09 31) 20 96-0  
Telefax (09 31) 20 96-146  
E-Mail wuerzburg@vbh.de

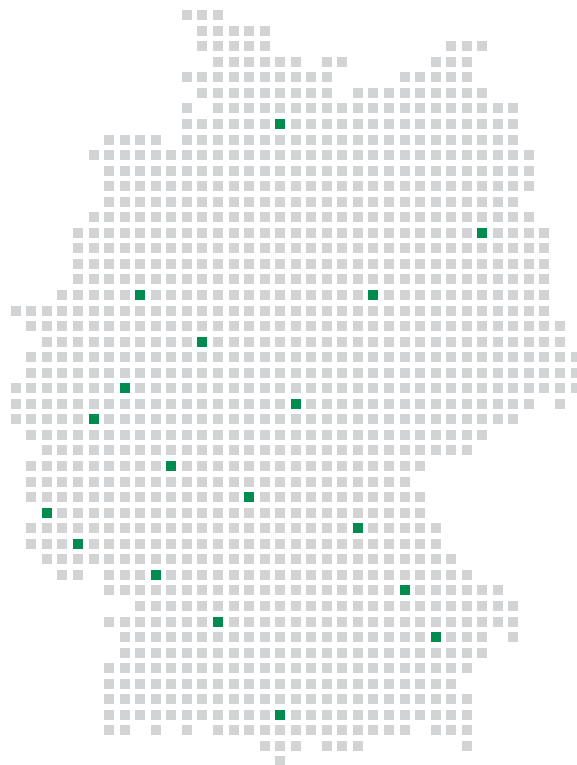



The expert brand for window and door hardware.

- More choice
- More service
- More brands
- More quality



- More advice
- More local
- More experience
- More reliability